



8690i Strap Glove

Quick Start Guide

Part Numbers: 8690i505RHSG, 8690i505LHSG



Caution: We recommend the use of Honeywell accessories and power adapters. Use of any non-Honeywell accessories or power adapters may cause damage not covered by the warranty.



Caution: Make sure that all components are dry prior to using the computers and batteries with accessories. Using wet components may cause damage not covered by the warranty.

Glove Features - Front

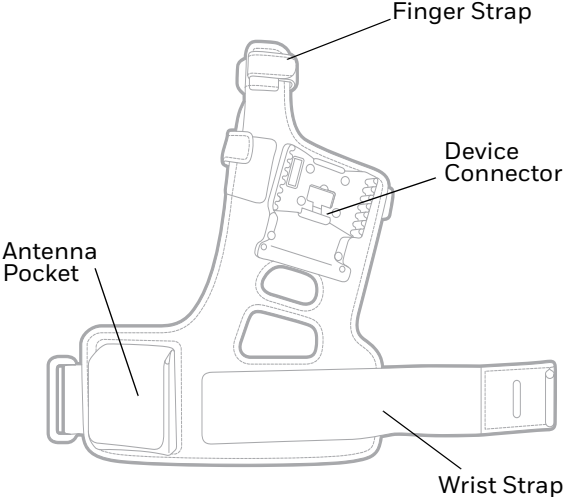

Glove Features - Back

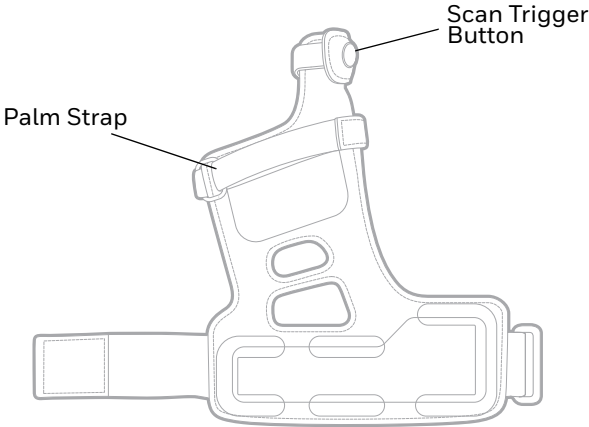

Connect the 8690i to the Glove

1. Connect the 8690i to the Glove.

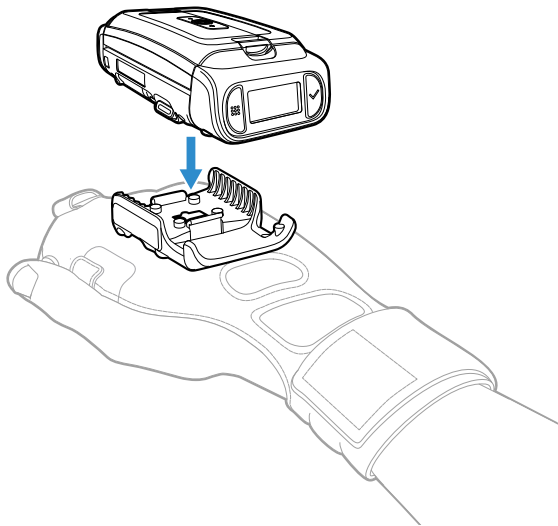

Wear the Glove

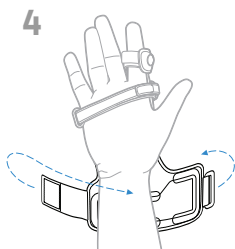
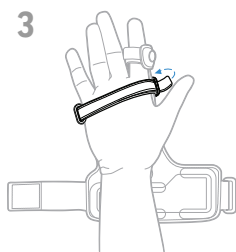
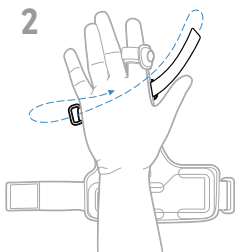
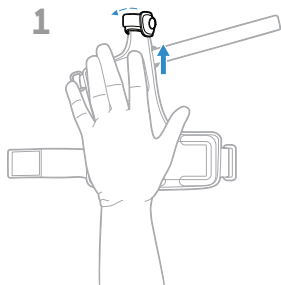

Remove the Glove

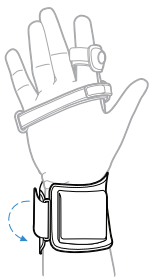

1

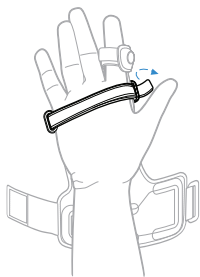

2

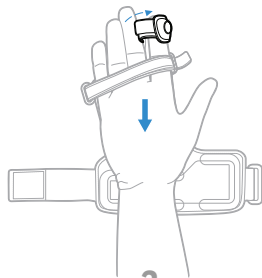

3

Scan Bar Codes

Press the button on the index finger to scan.

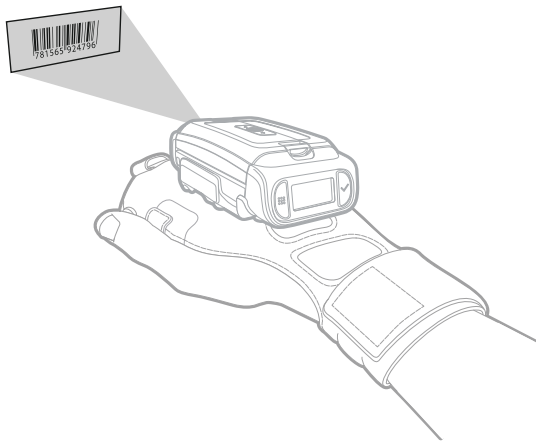

Remove the Antenna

1

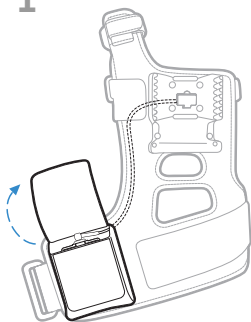

2

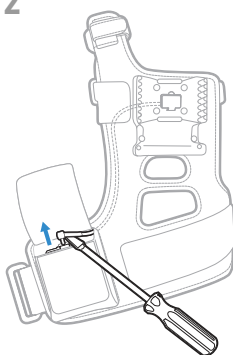

3

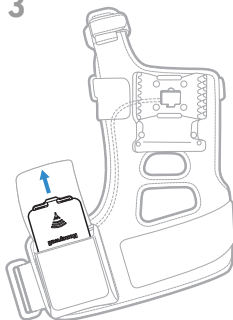

Replace the Antenna

1

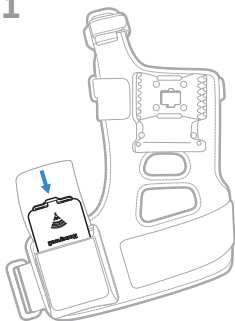

2

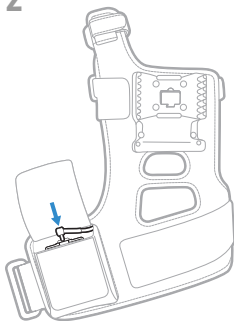

3

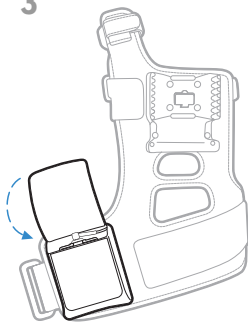

Remove the Cable

1

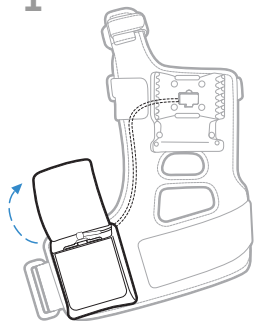

2

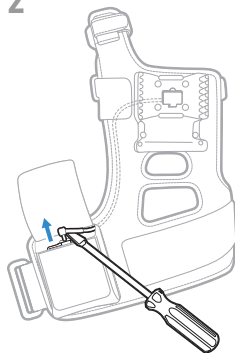

3

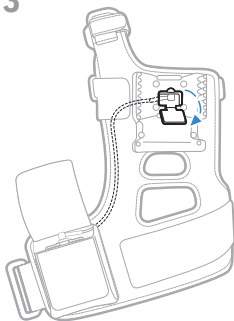

Remove the Cable (continued)

4

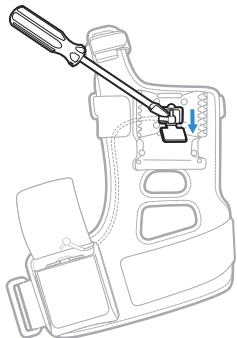

5

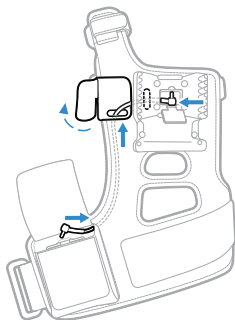

6

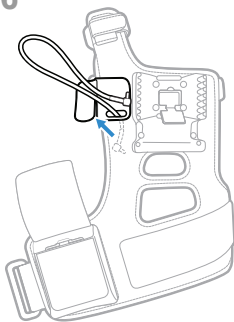

Replace the Cable

1

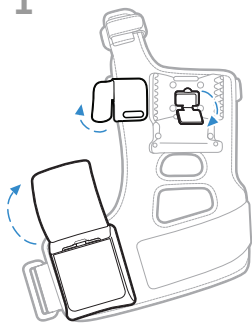

2

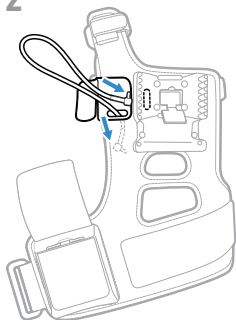

3

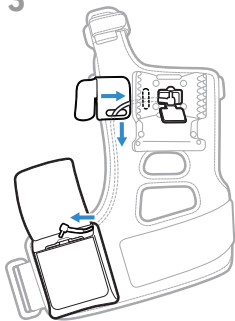

Replace the Cable (continued)

You can use a tool to snap the connector back in. Tweezers can be used to hold or align the cable and snap it in place.

4

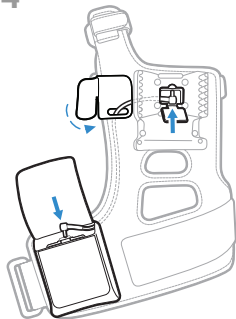

5

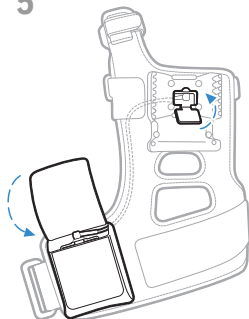

6

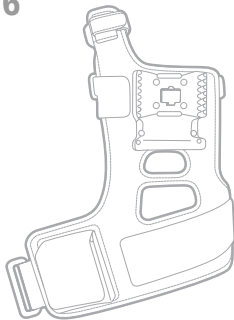

Remove the Palm Strap

1

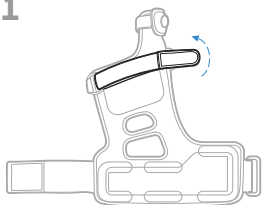

2

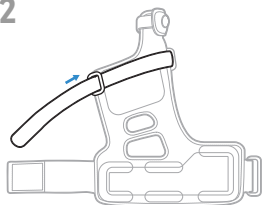

3

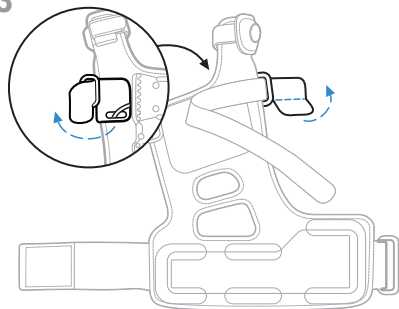

4

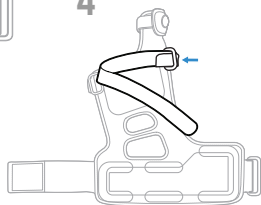

Replace the Palm Strap

1

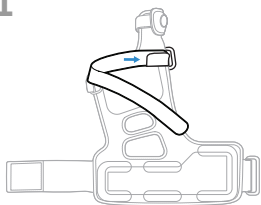

2

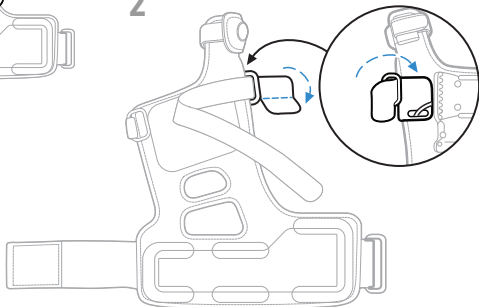

3

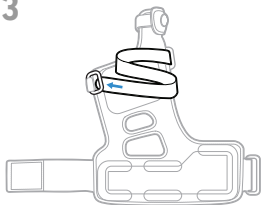

4

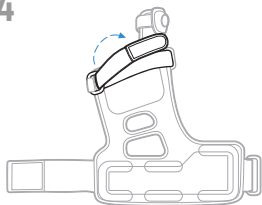

Support

To search our knowledge base for a solution or to log into the Technical Support portal and report a problem, go to www.hsmcontactsupport.com

Product Documentation

Product documentation is available at www.honeywellaidc.com.

Limited Warranty

For warranty information, go to www.honeywellaidc.com and click **Resources > Product Warranty**.

Patents

For patent information, see www.hsmpats.com.

Disclaimer

Honeywell International Inc. (HII) reserved the right to make changes in specification and other information contained in this document without prior notice, and the reader should in all cases consult HII to determine whether any such changes have been made. The information in this publication does not represent a commitment on the part of HII.

HII shall not be liable for technical or editorial errors or omissions contained herein; nor for incidental or consequential damages resulting from the furnishing, performance, or use of this material. HII disclaims all responsibility for the selection and use of software and/or hardware to achieve intended results.

This document contains proprietary information that is protected by copyright. All rights are reserved. No part of this document may be photocopied, reproduced, or translated into another language without the prior written consent of HII.

Copyright © 2021 Honeywell International Inc. All rights reserved.