

**Honeywell**

# RT10W

**Rugged Tablet**

powered by Windows® 10 IoT Mobile Enterprise



---

**User Guide**

---

# Disclaimer

Honeywell International Inc. (“HII”) reserves the right to make changes in specifications and other information contained in this document without prior notice, and the reader should in all cases consult HII to determine whether any such changes have been made. HII makes no representation or warranties regarding the information provided in this publication.

HII shall not be liable for technical or editorial errors or omissions contained herein; nor for incidental or consequential damages resulting from the furnishing, performance, or use of this material. HII disclaims all responsibility for the selection and use of software and/or hardware to achieve intended results.

This document contains proprietary information that is protected by copyright. All rights are reserved. No part of this document may be photocopied, reproduced, or translated into another language without the prior written consent of HII.

Copyright © 2023 Honeywell Group of Companies. All rights reserved.

Web Address: [sps.honeywell.com](https://sps.honeywell.com)

# Trademarks

Microsoft, Windows, Windows 10 IoT Mobile Enterprise and the Windows logo are registered trademarks of Microsoft Corporation in the United States and/or other countries.

The Bluetooth trademark is owned by Bluetooth SIG, Inc., U.S.A. and licensed to Honeywell.

Other product names or marks mentioned in this document may be trademarks or registered trademarks of other companies and are the property of their respective owners.

# Patents

For patent information, refer to [www.hsmpats.com](https://www.hsmpats.com).

# TABLE OF CONTENTS

Customer Support .....	vii
Technical Assistance .....	vii
Product Service and Repair .....	vii
Limited Warranty .....	vii
<b>Chapter 1 - Tablet Features.....</b>	<b>1</b>
RT10 Rugged Tablet.....	1
Tablet Features.....	2
About the Battery .....	3
Charge the Battery .....	4
Charge Before Use .....	4
Replace the Battery.....	5
LED Indicator Status .....	5
Check the Battery Settings .....	6
Battery Life and Conservation.....	6
Battery Recommendations and Safety Precautions .....	6
Enable Airplane Mode .....	7
Set Up the Tablet for the First Time .....	8
Turn the Power On or Off .....	8
Turn Sleep Mode On or Off .....	8
Adjust the Display Sleep Time .....	9
Unlock the Screen .....	9
Set a PIN to Protect the Tablet.....	9
Select a Touch Screen Profile to Optimize Performance.....	10
Configure the Screen Backlight.....	10

Audio Features .....	11
Adjust Volume.....	11
Audio Settings .....	12
Install a Micro SIM Card.....	12
Insert a microSD Card (Optional).....	14
Accessories for the RT10W .....	14

## **Chapter 2 - User Interface and Applications ..... 15**

Microsoft Windows.....	15
Drive C Folder Structure .....	15
User Interface.....	15
Start Screen .....	16
Status Bar Icons.....	16
Navigation and Function Buttons .....	17
Screen Gestures.....	17
View HotTab Utility.....	17
Camera .....	19
Device On/Off.....	19
Setting .....	20
View Software and Hardware Information .....	21
Software.....	21
Applications You Can Download to the Tablet .....	23

## **Chapter 3 - Use the Image Engine ..... 25**

The Scanner .....	25
Change the Scanner Settings .....	25
Connect to the Scanner .....	25
Select Scanning Mode .....	26
Symbology Settings .....	26
Reset to Scanner Defaults .....	27
Scan a Barcode .....	28

**Chapter 4 - Use the Camera .....29**

- Color Camera .....29
  - Enabling the Camera .....29
  - Adjust the Camera and Video Settings .....29
  - Take a Photo .....30
  - Record a Video .....31

**Chapter 5 - Configure the Computer .....33**

- Windows Control Panel.....33
  - About .....33
  - Bluetooth Printing.....34
  - Bluetooth Scanning.....35
  - Enterprise Settings .....39
  - Options .....45
  - Sounds.....45
  - ZoomZone.....46
- Windows Settings App .....48
  - Structure of the Settings App .....48
  - User Accounts .....49
  - Set the Date, Time, or Time Zone.....49
  - Region and Language .....50
  - Check for Windows Updates .....51
- Barcode Readers .....51
- Scanner (Virtual) Wedge .....51
- Network Communications.....51
  - View Network Information.....52
  - Connect to a Wi-Fi Network.....52
  - Connect to a Hidden Wi-Fi Network.....52
  - Modify Channel Settings.....53
  - Change Roaming Settings.....53
  - Connect to an Ethernet Network.....54
  - How to Connect to Virtual Private Networks.....54
- Wireless Security .....55

Certificates.....	55
Install a Certificate with Microsoft Edge .....	55
Install a Certificate with Email.....	55
Install a Certificate with MDM .....	56
Bluetooth Communications .....	56
Connect a Bluetooth Device .....	56
Disconnect a Paired Device.....	57
Serial and USB Communications.....	57
Developer Information.....	57

## **Chapter 6 - Manage and Maintain the RT10W ..... 59**

About Software Updates .....	59
Software Downloads .....	59
View Network Adapter Information.....	60
How to Restart the Tablet .....	60
Restart the Tablet .....	60
Restart in Safe Mode.....	61
Reset the Tablet to Factory Default State .....	61
Recover or Update Windows OS .....	62
Requirements .....	62
Installation.....	62
Use PXE Boot to Load an Operating System .....	63
Repairs .....	63
Maintenance.....	63
Clean the Tablet.....	64

## **Appendix A - Specifications..... 65**

Computer Agency Information.....	65
Label Locations .....	65
Physical and Environmental Specifications .....	65
Barcode Symbolologies Supported.....	66
N6703SR Ultra-Slim Imager .....	67
N6703 Imager Field of View/Resolution .....	68

N6803 FlexRange Imager.....	69
N6803FR Field of View/Resolution.....	70
Port and Connector Pinouts .....	71
Docking Connector .....	71





# Customer Support

## Technical Assistance

To search our knowledge base for a solution or to log in to the Technical Support portal and report a problem, go to [honeywell.com/PSStechnicalsupport](https://honeywell.com/PSStechnicalsupport).

For our latest contact information, see [honeywell.com/PSSlocations](https://honeywell.com/PSSlocations).

## Product Service and Repair

Honeywell International Inc. provides service for all of its products through service centers throughout the world. Go to [sps.honeywell.com](https://sps.honeywell.com) and select **Support > Productivity** to find a service center near you or to get a Return Material Authorization number (RMA#) before returning a product.

For ongoing and future product quality improvement initiatives, the terminal comes equipped with an embedded device lifetime counter function. Honeywell may use the lifetime counter data for future statistical reliability analysis as well as ongoing quality, repair and service purposes.

## Limited Warranty

For warranty information, go to [sps.honeywell.com](https://sps.honeywell.com) and select **Support > Productivity > Warranties**.



# TABLET FEATURES

This chapter introduces the RT10 Rugged Tablet with Windows® 10 IoT Mobile Enterprise operating system. Use this chapter to learn about the basic tablet features, functions, and accessories.

## RT10 Rugged Tablet

The Honeywell RT10 Rugged Tablet is designed for rapid user adoption, minimized total cost of ownership, and optimized device management.

Throughout this manual, all versions of the tablet are referred to as the RT10 unless information is specific to a particular model.

The RT10 Rugged Tablet features:

- Windows 10 IoT Mobile Enterprise operating system
- 4 GB SODIMM DDR3L-1600
- LED panel IPS display with LED backlight
- 1D/2D barcode reader
- Top-tier rugged specifications with IP65 sealing against dust and water
- Hot-swappable battery
- Optional high-capacity battery pack
- Optional expansion port for USB/RS232 connection
- IEEE 802.11 a/b/g/h/n/ac radio
- Bluetooth radio
- 10-point multi touch, with rain, glove and stylus modes
- microSDXC™ slot for removable memory cards (up to 2TB)
- Integrated GPS receiver (with WWAN radio option)
- 8-megapixel rear color camera with flash, 2-megapixel webcam
- Receiver Category 3 in accordance with EN 300 440-1

# Tablet Features

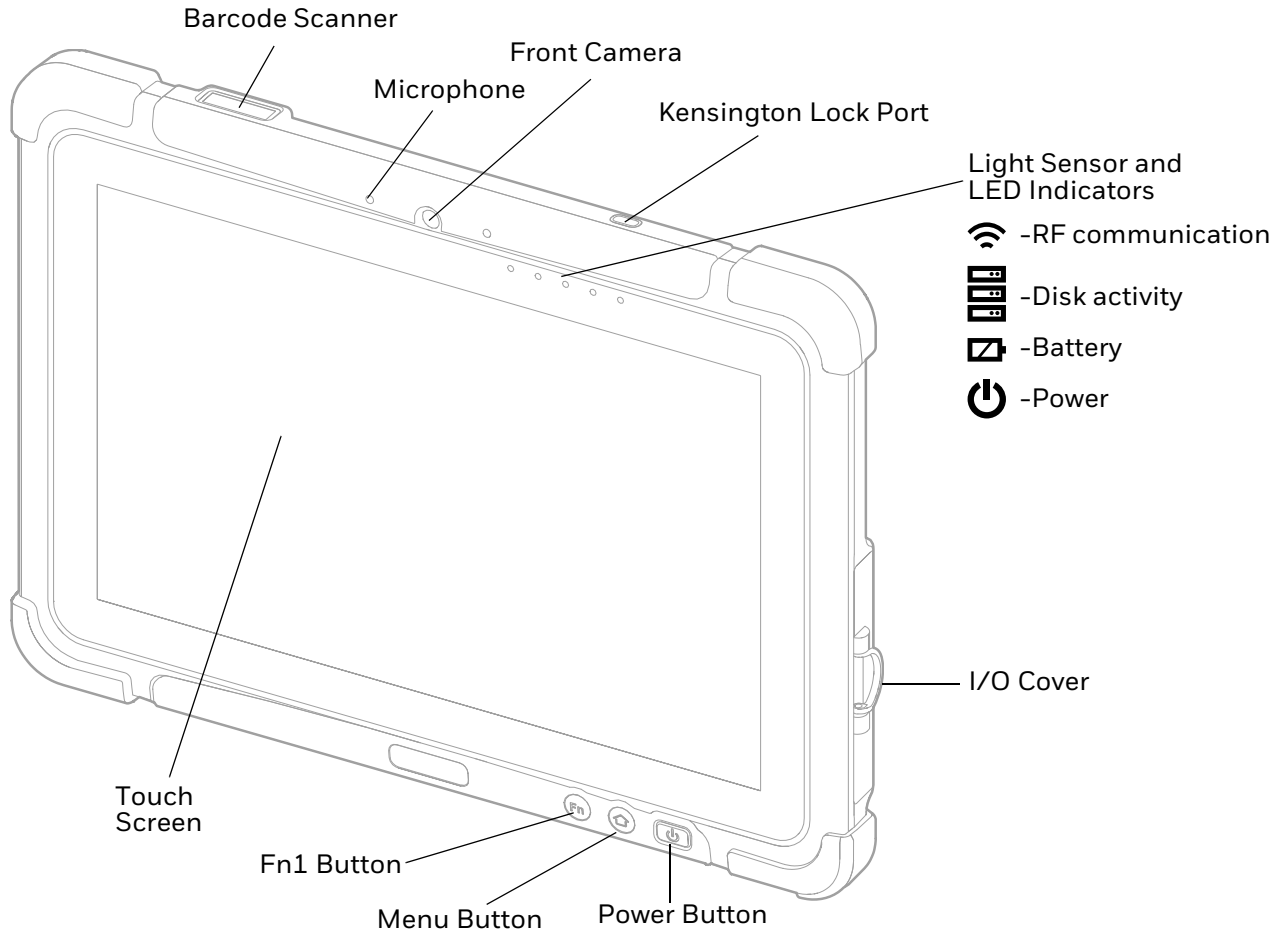

**I/O Panel**  
(I/O cover open)

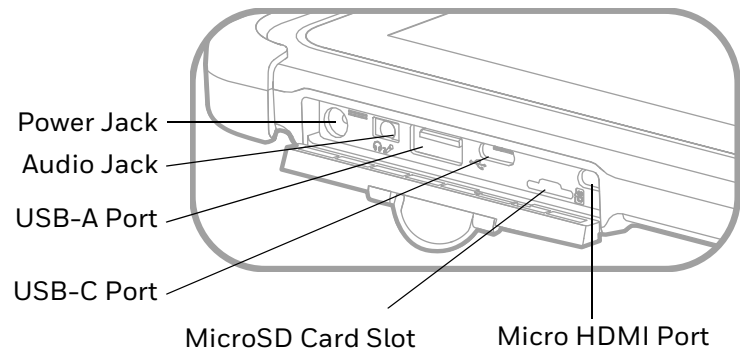

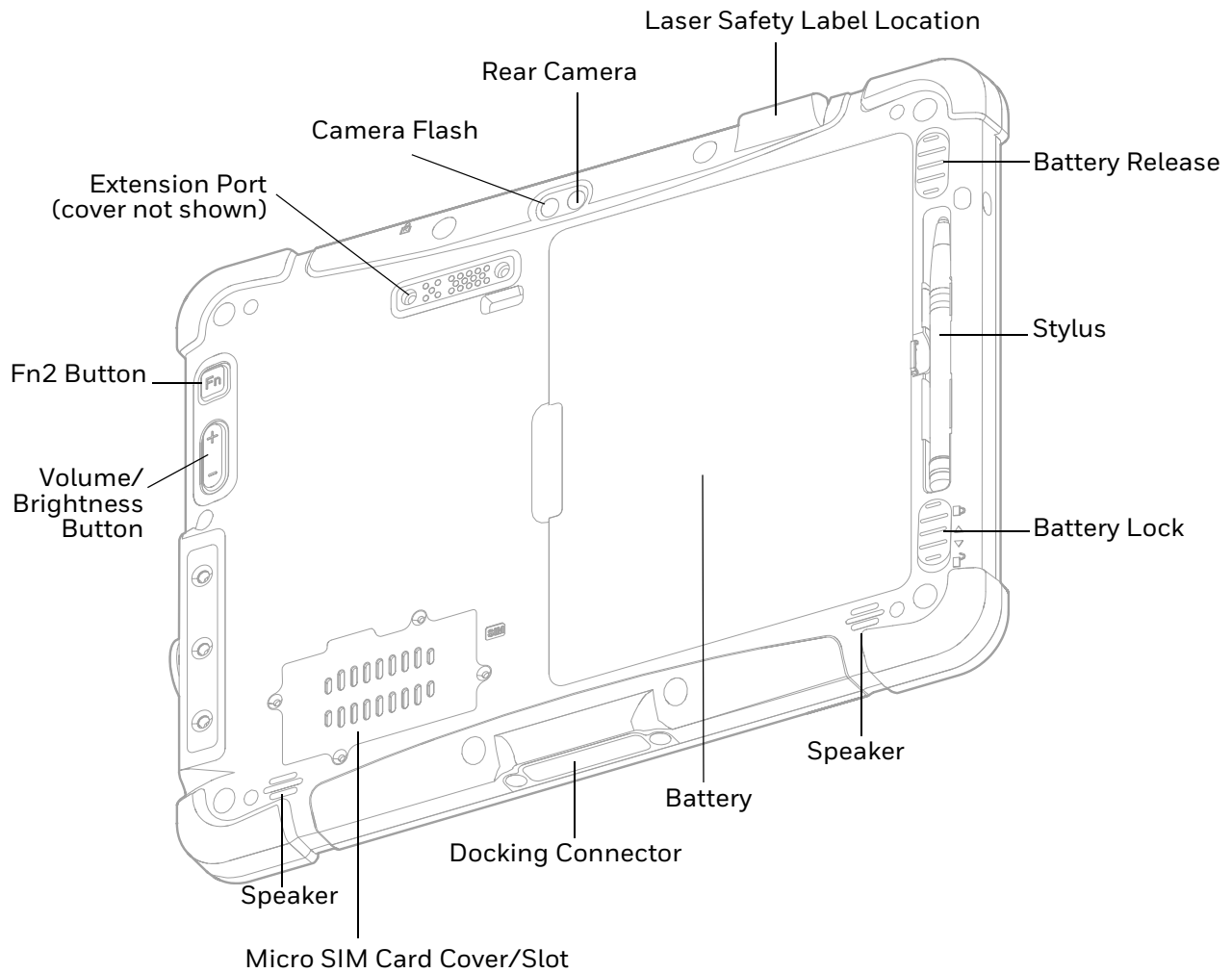

## About the Battery

The tablet uses a rechargeable Li-polymer battery as its main power source. Several factors determine the life of your battery, such as display brightness, display timeout, input device, extreme temperature, and usage. Honeywell recommends that you keep the battery charged at all times to prevent data loss.

RT10 tablets are designed for use with standard battery model RT10-BAT-STD1 and extended capacity battery model RT10-BAT-EXT1 manufactured for Honeywell International Inc.

**Note:** To view specifications specific to your battery model, see the battery insert supplied with the battery.

For a list of compatible charging accessories for the RT10W tablet and their part numbers, see the RT10 Rugged Tablet *Accessories Guide*, available for download from [sps.honeywell.com](http://sps.honeywell.com). Contact your local sales representative for replacement battery ordering information.



**Caution:** Read **Battery Recommendations and Safety Precautions** on page 6 and all cautionary markings on the battery, charging peripheral, and device using the battery before attempting to install, use, or charge the battery.

## Charge the Battery

RT10W tablets ship with the battery significantly discharged of power. Fully charge the battery before using your tablet for the first time. A fully discharged battery charges in approximately 6 hours.

**Note:** *Using the tablet while charging the battery increases the time required to reach a full charge.*

## Charge Before Use

Make sure you fully charge the battery before you use your tablet. You can charge the battery before or after you install it in the tablet. It takes about 6 hours for the battery to fully charge.

We recommend using AC power when you start the tablet for the first time.



**Caution:** We recommend use of Honeywell Li-poly battery packs. Use of any non-Honeywell battery may result in damage not covered by the warranty.



**Caution:** Ensure all components are dry prior to placing the battery in the tablet. Mating wet components may cause damage not covered by the warranty.

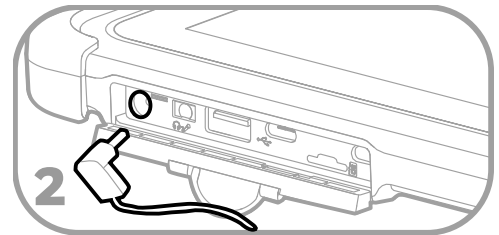
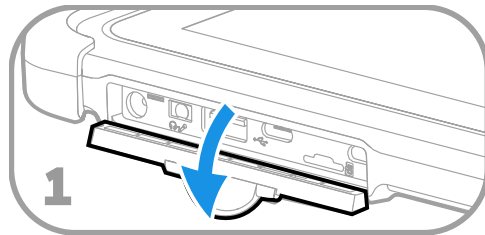

**Caution:** We recommend the use of Honeywell accessories and power adapters. Use of any non-Honeywell accessories or power adapters may cause damage not covered by the warranty.





**Caution:** Ensure all components are dry prior to mating the computers and batteries with peripheral devices. Mating wet components may cause damage not covered by the warranty.

# Replace the Battery

If your battery power is low, you need to either charge the battery in the tablet or replace it with a charged battery.

## Hot Swap

The RT10W Tablet has an internal backup battery that is charged with the main battery. This battery cannot be removed and requires adequate power for main battery hot swapping. When the backup battery is fully charged, the tablet can sustain up to 5 minutes of runtime for battery hot-swapping.





1. Press the Menu button or double-tap  to open the HotTab app.
2. Tap  **Setting** to check the power level of the backup battery.
3. If the backup battery level is at least medium, remove the main battery. Otherwise, charge the tablet until the backup battery level is medium or higher before removing the main battery.
4. Insert a new, fully charged battery into the battery compartment.



**Caution: Charge the built-in backup battery every two months to maintain battery health and prevent possible issues from battery over-discharge.**



## LED Indicator Status

The LED indicators are located in the upper right of the tablet:

LED	Name	Status
	RF Communications	Green - WiFi/BT/WWAN/GPS are ON No light - WiFi/BT/WWAN/GPS are all OFF
	Disk Activity	Blinking Green - Disk activity is in process No light - The disk is idling
	Battery	Orange - The AC adapter is plugged in and the battery is charging Green - The AC adapter is plugged in and the battery is fully charged Solid Red - The battery is low (<10%) Blinking Red - Battery hot swap is in process No light - The battery is in use and has more than 10% charge
	Power	Blue - Tablet is on No light - Tablet is off

# Check the Battery Settings

In addition to the Battery status LED, you can get information about both the main battery and the backup battery from the HotTab app.

1. To open HotTab, press the Menu button or double-tap .
2. Tap  **Setting**. The status of both batteries displays.

# Battery Life and Conservation

If you store the batteries outside the tablet for long periods of time, they slowly discharge. Honeywell recommends storing the battery in a charger to maintain battery performance.

When you want to:	Do this to save battery power
Use the tablet, and the battery status LED turns red	Connect the tablet to an external power source to charge. Or, swap the battery for a fully charged one (see <a href="#">Hot Swap</a> on page 5).
Stop using the tablet for 5 minutes or more	Press the Power button to suspend the tablet.
Store the tablet for more than a day	If you are storing the tablet for a few days (such as over the weekend), install a charged battery or connect the tablet to a power source. If you are storing the tablet for a longer period of time, fully charge the battery. When the battery is done charging, store both the battery and the tablet in a cool location. If you store the battery for several months, recharge the battery periodically to keep it at peak performance.
Store the battery outside the tablet	Store the battery in a charger.

# Battery Recommendations and Safety Precautions

- To learn more about Battery Maintenance for Portable Devices, go to [honeywell.com/PSS-BatteryMaintenance](http://honeywell.com/PSS-BatteryMaintenance).
- Charge the battery before use. Battery ships with a partial charge only.
- See [Charge the Battery](#) on page 4 for approved charging methods. Use of this battery in other devices could result in damage to the device or battery.
- The temperature range for charging this battery is 0 °C to 45 °C (32 °F to 114 °F). Do not charge the battery outside this range.
- For maximum battery life if storage is more than 3 months, charge the battery at 15 °C to 35 °C (59 °F to 95 °F) and store at 25±3°C (77±5°F) with a 50% charge.
- Do not store the battery at temperatures above 60 °C (140°F), such as inside a car on a hot day or in direct sunlight. Storage above 60 °C (140°F) may damage the battery.





- Avoid dropping the battery or computer. If you suspect the battery and/or computer is damaged or if intermittent power and charging issues occur, send the relevant device(s) to a Honeywell service center for inspection of the computer and/or battery.
- Replace this battery only with another RT10 battery as identified below. These batteries have been tested in accordance with applicable safety standards. Contact your Honeywell sales representative or distributor if this battery is no longer available.

Version	Battery Model Number
Standard	RT10-BAT-STD1
Extended	RT10-BAT-EXT1

- Discarded batteries may create a safety hazard. Before disposal, cover the battery contacts with electrical insulating tape.
- Do not modify the battery or attempt to insert foreign objects into it.
- Do not solder directly to the battery contacts.
- Do not short circuit the battery, and keep it away from metallic items.
- Do not drop the battery or apply mechanical shocks or pressure to it.
- Do not disassemble or open, crush, bend or deform, puncture, shred or burn the battery.
- Do not immerse the battery in water or get the battery wet.
- Battery usage by children should be supervised.

## Enable Airplane Mode

If you do not need to connect to any wireless networks, you can enable Airplane mode to turn off all the radios and save battery power.

1. Tap .
2. Tap .
3. Tap **Network & Internet**.
4. Tap **Airplane mode**.
5. Tap the toggle to turn Airplane Mode on. The Airplane Mode icon displays in the status bar.

# Set Up the Tablet for the First Time



**Caution:** If a power interruption occurs during Windows set up, access the Recovery menu by pressing the Fn1 button (see page 61).

The first time you power on the tablet, a Welcome screen displays. Once setup is complete, the Welcome screen no longer displays on startup.

1. Press and hold the Power button for approximately 3 seconds until the blue LED power indicator lights up.
2. Using your finger or the stylus, select your region and then tap **Yes**.
3. Follow the on-screen prompts to finish setting up the tablet.

To learn more about what you can do with a Microsoft account, go to <https://account.microsoft.com/about>.

## Turn the Power On or Off

To turn the tablet on:

- Press and hold the **Power** button for approximately 3 seconds until the blue LED power indicator lights up.



**Caution:** Do not press the power button repeatedly.



**Caution:** Do not attempt to connect or disconnect the AC adapter or press the tablet's screen, buttons or external keyboard/mouse until the Disk Activity indicator turns off.

To turn the tablet off:

1. Tap .
2. Tap .
3. Tap **Shut down**.

## Turn Sleep Mode On or Off

Sleep mode automatically turns the touch panel display off and locks the tablet to save battery power when the tablet is inactive for a programmed period of time.

To turn Sleep Mode on:



1. Tap .
2. Tap .
3. Tap **Sleep**.

To wake the tablet from sleep mode and unlock the screen:

1. Press and release the Power button.
2. Swipe up from the bottom of the screen to unlock the tablet.

## Adjust the Display Sleep Time

To adjust the amount of time before the display sleeps after inactivity:

1. Tap .
2. Tap .
3. Tap **Personalization** and then **Lock screen**.
4. Scroll down and tap **Screen timeout settings**.
5. Select an amount of time from the drop-down list.
6. Close the window to return to the Home screen.

## Unlock the Screen



Every time you power on the tablet, you will need to unlock it.

- Swipe up from the bottom of the screen to unlock it.

The level of security provided depends on the type of lock set (e.g., swipe, PIN, or password). The default setting, swipe, provides no protection against unauthorized access to your computer.

## Set a PIN to Protect the Tablet

After you start using the tablet, you should set a PIN to secure apps and data on the tablet.



1. Tap .
2. Tap .
3. Tap **Accounts**.
4. Tap **Sign-in options**.
5. Click **Add** under **PIN**.
6. Enter your password then tap **OK**.
7. Type your PIN in the **New PIN** textbox.
8. Type your PIN again in the **Confirm PIN** text box.
9. Tap **OK**.

10. Exit the Settings app.

## Select a Touch Screen Profile to Optimize Performance

Optimize screen interactions by selecting a touch screen setting designed specifically for your use case. For example, if you wear gloves, set the touch screen to Glove mode for the best touch screen response.

**Note:** Maximum glove thickness of 1.1 mm (0.045 inches) for touch screen response.



1. Press the Menu button or double-tap .
2. Tap  **Device ON/OFF**.
3. Tap  **Touch Set**.
4. Select a mode:

Mode	Supported Input
Hand/Rain (Default)	The touchscreen rejects false input from liquid drops. When the liquid is removed, the touchscreen accepts touch input from: <ul style="list-style-type: none"><li>• Active stylus with palm rejection</li><li>• Rubber tip passive stylus</li><li>• Bare fingertips</li></ul>
Stylus	<ul style="list-style-type: none"><li>• Fine-tip passive stylus with palm rejection</li><li>• Active stylus with palm rejection</li><li>• Rubber-tip passive stylus</li><li>• Bare fingertips</li></ul>
Glove	<ul style="list-style-type: none"><li>• Glove</li><li>• Rubber tip passive stylus</li><li>• Bare fingertips</li></ul>

You can also program the long press of a function key to change Touch Set. (See [Program the Function Buttons](#) on page 20.)

## Configure the Screen Backlight



The display has an ambient light sensor that automatically adjusts the backlight intensity to conserve power and ensure the display is readable. You can set the backlight as needed for your environment.

1. Press the Menu button or double-tap .
2. Tap  **Device ON/OFF**.

3. Tap  **Light Sensor** to toggle it on or off.  
Orange: the light sensor is on.  
White: the light sensor is off.

## Adjust Screen Brightness

You can manually adjust screen brightness using the Brightness/Volume button on the rear of the tablet (see page 3). Because the button is dual purpose, you must enable the brightness function in the HotTab app.

1. Press the Menu button or double-tap .
2. Tap  **Setting**.
3. Tap  **Brightness** to set the Brightness/Volume button to brightness control:  
Orange: the button is set to adjust screen brightness.  
White: brightness control is off and volume control is on (see [Adjust Volume](#) on page 11).
4. Press the Brightness/Volume button to adjust brightness up or down.

## Screen Blanking

When docked in a vehicle cradle or dock, the RT10 Rugged Tablet can be configured to blank (black out) the display while the vehicle is in motion.



Refer to [ZoomZone](#) on page 46 for information.

## Audio Features

The RT10W is equipped with speakers and a microphone.



## Adjust Volume

During playback you can adjust the volume using the Brightness/Volume button on the rear of the tablet (see page 3). Because the button is dual purpose, you must enable the volume function in the HotTab app.

1. Press the Menu button or double-tap .
2. Tap  **Setting**.
3. Tap  **Volume** to set the Brightness/Volume button to volume control:  
Orange: the button is set to adjust volume.  
White: volume control is off and brightness control is on (see [Adjust Screen Brightness](#) on page 11).
4. Press the Brightness/Volume button to adjust volume up or down.

## Audio Settings

Use the Settings app to configure the audio and sound settings.

1. Tap .
2. Tap .
3. Tap **System > Sound**.

## Install a Micro SIM Card

Only RT10WL10 (WWAN) models support micro SIM card use for cellular phone features.



**Caution:** Do not squeeze or disconnect cables when removing or inserting the 3G/LTE module.

**Note:** Always power off the tablet before attempting to install or remove a card.

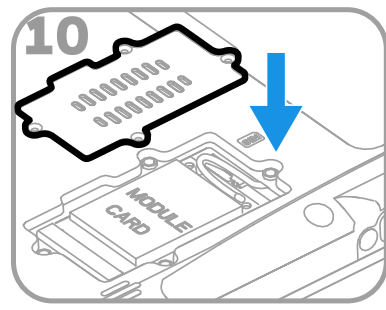
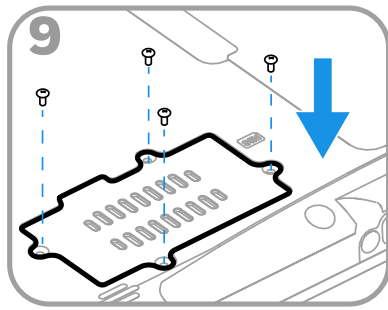
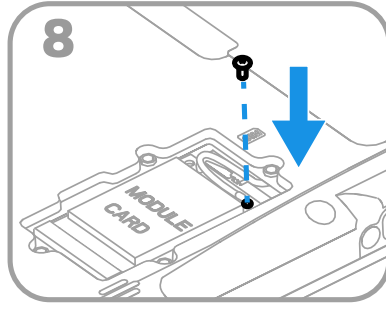
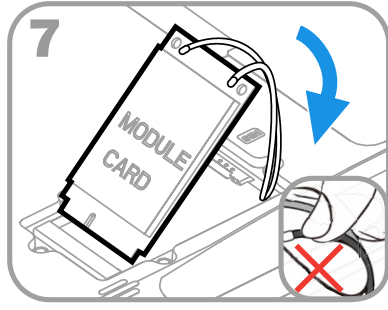
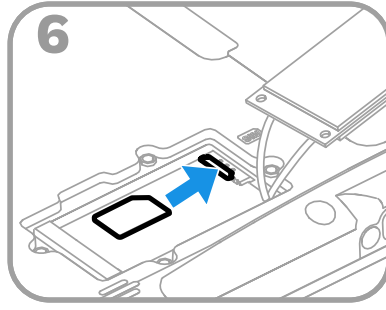
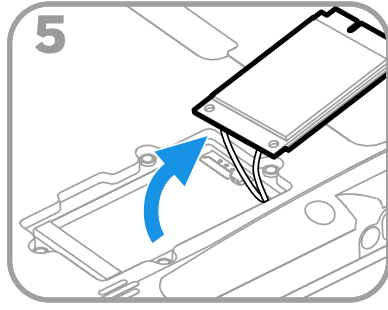
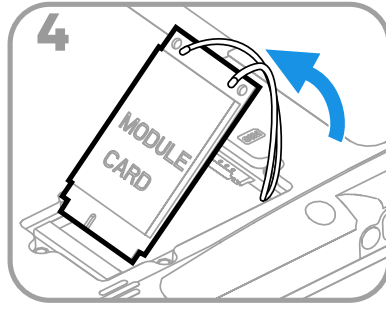
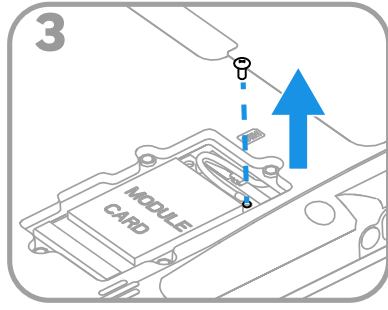
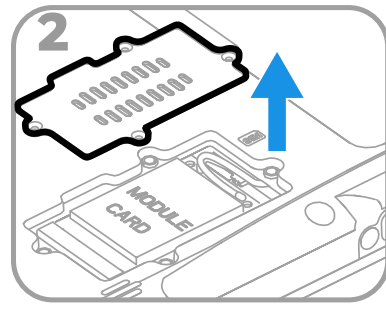
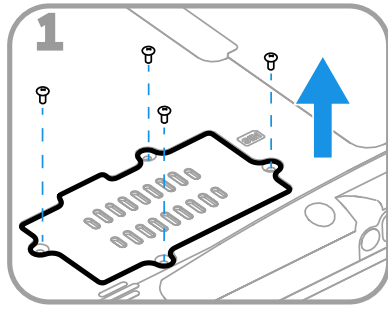

## Insert a microSD Card (Optional)

You can use a microSD card to increase file storage capacity or to install software. Honeywell recommends the use of Single Level Cell (SLC) industrial-grade microSD™ or microSDXC™ memory cards with RT10 Rugged Tablets for maximum performance and durability.

**Note:** Format memory card before initial use.

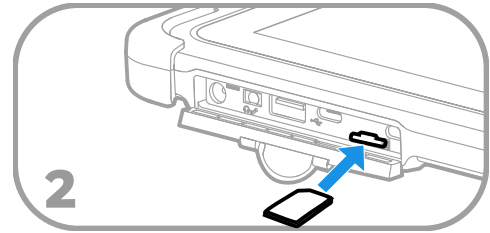
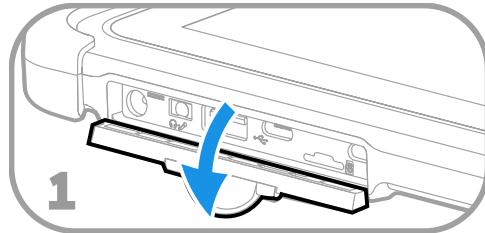

**Note:** Always power off the tablet before attempting to install or remove a card.

## Accessories for the RT10W

The RT10W ships with a standard battery and a stylus. All other accessories are ordered and shipped separately.

For more information about charging, communication and mounting accessories, see the *RT10 Accessories User Guide*, available on the RT10 product page at [sps.honeywell.com](https://sps.honeywell.com).

For ordering information and a list of all available RT10 accessories, contact your local sales representative.



# USER INTERFACE AND APPLICATIONS

Use this chapter to learn about the Windows user interface and how to interact with the screen. You can also use this chapter to learn about the Honeywell applications on the tablet.

## Microsoft Windows

After the system files are processed, Microsoft Windows begins to load. Windows maintains a System Registry and INI files. Standard Windows configuration options apply to the RT10W. Configuration options are located in the System Tray or the Control Panel:

- The System Tray contains icons for adjusting the time, date or volume level.
- The Control Panel contains icons for many other configuration options, such as Power Management, Regional and Language Options, etc.
- The Control Panel icons are also used to add, delete or modify software installed on the RT10W.

## Drive C Folder Structure

Microsoft Windows is installed in the \Windows folder. In addition, Microsoft Windows creates other folders and several subfolders. For more information on the folder structure, please refer to commercially available Microsoft Windows OS reference guides.

## User Interface

The Windows 10 IoT Mobile Enterprise operating system provides a touch-friendly and easy to navigate user interface.

## Start Screen

When you turn on the tablet, the Home screen is the first screen that appears after language provisioning is complete. The Status bar contains icons to the right to tell you current wireless and network connection state as well as date, time, and the battery level.







## Status Bar Icons

Status and notification icons show you the current status of your network, the battery, notifications, and the sounds.

Common Icons	Description
	An app or service is using tablet location information.
	Unread notification.
	Wi-Fi network connection is active with full signal strength.
	The tablet is paired and connected with a Bluetooth device.
	Battery is fully charged.
	Battery saver mode is on.
	The tablet is connected to external power. When the battery is charging, the battery charge and external power icons alternate.
	Airplane mode is on.

# Navigation and Function Buttons

There are navigation and function buttons on the front and the back of the tablet. For button locations, see [Tablet Features](#) on page 2.

Button	Name	Description
	Fn1	Programmable shortcut button. (The default is the web browser.)
	Menu	Display or hides the HotTab interface.
	Power	See <a href="#">page 8</a> .
	Fn2	Programmable shortcut button.(The default is the camera app.)
	Volume/ Brightness	Raise or lower the volume or brightness.

## Screen Gestures

Use your fingers or the stylus to manipulate icons, buttons, menus, the on-screen keyboard, and other items on the screen.



- To select or activate something, tap where you want to type. A keyboard displays that lets you type into the field.





Other common gestures include:

- **Touch and hold:** Touch and hold an item by touching it and pressing until an action occurs.
- **Drag:** Touch and hold an item for a moment. Without lifting your finger, move your finger or stylus on the screen until you reach the target position. For example, you can drag to reposition shortcuts on the Home screen.
- **Swipe or slide:** Quickly move your finger or stylus across the screen, without pausing when you first touch.
- **Double-tap:** Tap quickly twice on a web page, map, or other screen to zoom in. Double-tap again to zoom out.
- **Pinch:** In some apps, you can zoom in and out by placing two fingers on the screen at once and pinching them together (to zoom in) or spreading them apart (to zoom out).

## View HotTab Utility

Use HotTab to control all main functions of your tablet. When Windows starts up HotTab runs in the background.





To display the HotTab interface, press the  button or double-tap  on the Home screen. The HotTab interface displays on the right side of the Home screen.

Icon	Description
	Configure short cuts to quickly access programs (see next section).
	Take a picture, record a video, or adjust camera settings (see page 19).
	Enable/disable hardware functions such as Wi-Fi, WWAN (3G/4G/LTE), GPS, Bluetooth, camera, LED indicators, RFID reader, and GPS antenna outing (see <a href="#">Device On/Off</a> on page 19).
	Display battery status and device settings such as power management and function key mapping ().



## Shortcuts

The Shortcuts menu allows you to configure up to 8 quick access tabs that can be mapped to any executable files (.exe) installed on the tablet.



To store a new shortcut:

1. Press the  button or double-tap  on the Home screen to launch HotTab.
2. Tap  **Shortcut**.
3. Tap  next to an empty slot.
4. Browse to the desired application and select it.
5. Click **Open** to save the shortcut.

## Use Shortcuts

1. Press the  button or double-tap  on the Home screen to launch HotTab.
2. Tap  **Shortcut**.
3. Tap the shortcut.

## Remove Shortcuts

1. Press the  button or double-tap on the Home screen to launch HotTab.
2. Tap  **Shortcut**.
3. Tap  next to of any saved shortcut slot.



The shortcut is removed, and that slot displays as empty.









# Camera

The Camera HotTab menu option allows you take a picture or record a video. For more information, see [Use the Camera](#) on page 29.

# Device On/Off



The Device ON/OFF HotTab menu lets you set up or disable built-in devices. An orange icon indicates a feature is enabled. A white icon indicates the feature is disabled.



1. Press the  Menu button or double-tap .
2. Tap  **Device ON/OFF**.

Icon	Name	Description
	GPS External Antenna	Switch from the internal GPS antenna to an external antenna when the RT10W is inserted into a vehicle dock (see <a href="#">GPS External Antenna</a> on page 19).
	Light Sensor	Enable or disable the ambient light sensor (see <a href="#">Tablet Features</a> on page 2).
	Touch Set	Select a touch mode (see page 10).
	Ext. Module	Enable or disable an optional expansion module (e.g., smart card reader).
	Wi-Fi	Enable or disable Wi-Fi.
<b>WWAN</b>		Enable or disable 3G/4G (model dependent).
	GPS	Enable or disable global positioning.
	BT	Enable or disable Bluetooth.
	Camera	Enable or disable the camera (see <a href="#">Use the Camera</a> on page 29).
	Indicators	Turn the LED indicators on the front of the tablet on or off (see <a href="#">Tablet Features</a> on page 2).

## GPS External Antenna

The RT10W supports connection to an external GPS antenna through a standard SMA connector. To use this feature:

1. Connect the vehicle dock to an external antenna.
2. Ensure the tablet is securely seated in the vehicle dock.
3. Press the  Menu button or double-tap .

4. Tap  **Device ON/OFF**.
5. Tap . When the icon is orange (enabled), the external antenna is used.

To return to using the internal antenna, tap  again to disable the external antenna (the icon turns white).

## Setting

The Setting HotTab menu allows you to:



- Display software and hardware information (see page 21)
- Display information about the main and backup battery information
- Turn battery low temperature tips on or off
- Check for software updates
- Program the two function keys (see next section)
- Set up the Volume/Brightness button (see [Adjust Screen Brightness](#) on page 11)

## Program the Function Buttons



The function key mapping menu option allows you to change the physical function buttons, Fn1 and Fn2. See [Tablet Features](#) on page 2 for the location of these buttons.

You can change which application or file will be launched with either a short press of a function button or a long press. For the Fn1 button, the default functions are Browser for a short press and Touch Mode for a long press. For the Fn2 button, the defaults are Camera for a short press and Volume Mute for a long press.

To program the functions buttons:

1. Press the Menu button or double-tap .
2. Tap  **Setting**.
3. Tap the **f** icon for the corresponding function button that you want to change. The current setting for that button displays in orange.
4. Select **ff Short Press** or **ff Long Press**.
5. To choose an option from the preset list of applications, tap an icon.
6. To select a different application:
  - a. Tap .
  - b. Browse to the desired application and select it.
  - c. Tap **Open** to save.

# View Software and Hardware Information

1. Press the  Menu button or double-tap .
2. Tap  **Setting**. The following information displays:
  - BIOS version
  - EC Version
  - HotTab Version
  - OS Version
  - Serial Number
  - Model Name

## Software

The software loaded on the RT10W computer includes:

- Microsoft operating system (Windows 10)
- Device drivers
- Honeywell software

The software installed on the RT10W is summarized below.

**Note:** *Due to the complex folder structure and System Registry under Microsoft Windows, software should not be removed manually. Instead use the Windows Control Panel.*

## Microsoft Windows

Microsoft Windows is installed in the \Windows subfolder, which is the Windows default. In addition, Windows places files in other folders and subfolders during installation. For more information, please refer to commercially available Microsoft Windows OS user guides.

## Device Drivers

Device drivers are installed for all installed hardware options, such as the display, touch screen, radios, etc. For more information on Microsoft Windows device drivers, please refer to commercially available Windows OS reference guides. For information on updating Honeywell drivers, see page [59](#)

## Radio Software

The RT10W is delivered with the radio software installed. Because the RT10W uses a Microsoft Windows operating system, the radio installation includes Windows device drivers.

## Enterprise Client Pack

There are several components of the Enterprise Client Pack installed on the RT10W. For more information on these programs visit the RT10W product page at [sps.honeywell.com](http://sps.honeywell.com).

## Enterprise TE

Tap  > **Honeywell > Enterprise TE**

Optional terminal emulation software. The application can also be accessed by double-clicking the Enterprise TE desktop icon.

## Enterprise Browser

Tap  > **Honeywell > Enterprise Browser**

Enterprise Browser for Microsoft® Internet Explorer® is a locked-down enterprise Web client application designed for Honeywell computers. It provides a controlled Web application environment that helps enterprises increase productivity and reduce IT management expenses. You can configure Enterprise Browser for your specific application requirements and design custom web applications that run through the Enterprise Browser to provide your users with an easy-to-use yet controlled experience.

If Enterprise Browser is not included on your computer model, you can download a trial version for evaluation. After the evaluation period expires, you need to purchase a license. For more information about Enterprise Browser, visit [sps.honeywell.com](http://sps.honeywell.com).

## Launcher

Tap  > **All Apps > Honeywell > Launcher**

Launcher is a configurable locked-down menu program designed for Honeywell computers that prevents end-users from accessing the start menu and other non-authorized applications. Use Launcher to provide a platform where your mobile computer users are limited to running only company-approved applications and prevent them from initiating unauthorized configuration changes. You can also use Honeywell Launcher together with Honeywell Enterprise Browser to create a single-purpose device configuration.

If Launcher is not included on your computer model, you can download a trial version of the software for evaluation. After the evaluation period expires, you need to purchase a license. For more information about Launcher, visit [sps.honeywell.com](http://sps.honeywell.com).



## EZConfig for Scanning

EZConfig for Scanning supports advanced customization and configuration of the tablet. EZConfig includes a standard XML editor and a configuration barcode scanner feature. You can use EZConfig for Scanning to configure the image engine of the RT10W. (See [Change the Scanner Settings](#) on page 25.)

For more information about EZConfig for Scanning, visit [sps.honeywell.com](https://sps.honeywell.com).

## Applications You Can Download to the Tablet

You can download Honeywell applications to extend the capabilities of the tablet. You may need to purchase a license to run some applications. To learn more about Honeywell software solutions, go to [sps.honeywell.com](https://sps.honeywell.com) and select **Software > Productivity**.

### CloneNGo

CloneNGo is a peer-to-peer device cloning application that easily transfers the configuration of a master computer to one or more clone (client) computers. CloneNGo is available for download from the Technical Support Downloads Portal (see [About Software Updates](#) on page 59).

For more information about using CloneNGo on the RT10W, refer to the CloneNGo User Guide available at [sps.honeywell.com](https://sps.honeywell.com).



# USE THE IMAGE ENGINE

Use this chapter to understand how to scan barcodes, configure the scan settings, and capture images using the integrated imager in the tablet.

## The Scanner

The internal scanner can read 1D and 2D barcode symbologies, composite symbologies, and postal codes. It also supports omni-directional scanning for greater flexibility in real-world settings. The image engine can also capture black and white images, such as signatures and pictures of damaged inventory.



**Warning: Do not stare into the imager laser aimer.**

## Change the Scanner Settings

The EZConfig-Scanning app allows you to format the image engine. For more information about using EZConfig-Scanning, access the Help system within the app.

## Connect to the Scanner

1. Start the EZConfig-Scanning app .
2. Allow blocked content if prompted.
3. Tap **CONNECTED DEVICE**. The device discovery process may take a few moments.
4. Once the image engine is discovered, tap **CONFIGURE DEVICE** to retrieve the scanner configuration.

## Select Scanning Mode

1. Connect to the image engine using EZConfig-Scanning as shown in [Connect to the Scanner](#) above.
2. On the Input/Output Settings tab, tap **Device Settings**.
3. Select the desired scanning mode from the drop-down menu.

The RT10W supports the following scanning modes:

Scanning Mode	Description
Manual Trigger	(Default) When in manual trigger mode, the scanner scans until a barcode is read, or until the trigger is released. Two modes are available: Normal and Enhanced. Normal mode offers good scan speed and the longest working ranges (depth of field). Enhanced mode will give you the highest possible scan speed but slightly less range than Normal mode. Enhanced mode is best used when you require a very fast speed and don't require a long working range.
Presentation Mode	Presentation Mode uses ambient light and scan engine illumination to detect barcodes. When in Presentation Mode, the LEDs remain dim until a barcode is presented to the scan engine, then the aimer turns on and the LEDs turn up to read the code. If the light level in the room is not high enough, Presentation Mode may not work properly.
Snap and Ship Mode	Snap and Ship mode allows you to bypass the decoder and ship an image directly to the host. In this mode, an image is taken and shipped upon each trigger pull, instead of being sent to the decoder. Snap and Ship is useful when you are using your own decoder.
Streaming Presentation Mode	When in Streaming Presentation mode, the scan engine's aimer goes out after a short time, but the scan illumination remains on all the time to continuously search for barcodes. Two modes are available: Normal and Enhanced. Normal mode offers good scan speed and the longest working ranges (depth of field). Enhanced mode will give you the highest possible scan speed but slightly less range than Normal mode. Enhanced mode is best used when you require a very fast scan speed and don't require a long working range.

4. Tap **Save to Device** in the sidebar.

## Symbology Settings

The Symbology settings define the barcode symbologies the scanner will decode.

1. Connect to the image engine using EZConfig-Scanning as shown on [page 25](#).
2. Select the **Symbologies** tab.
3. The symbologies are grouped by type. Navigate between groups by using the tabs and sub-tabs.
4. Tap the toggle next to a symbology to enable or disable it.

5. Change any advanced settings as needed.
6. Tap **Save to Device** in the sidebar.

For a complete list of all available symbologies, see Appendix A, [Specifications](#), beginning on page 65.

## Reset to Scanner Defaults

To undo any changes made to the scanner settings and return all values to their defaults:

1. Connect to the image engine using EZConfig-Scanning as shown on [page 25](#).
2. Tap **RESET TO DEFAULT** in the sidebar.

**Note:** *If the image engine disconnects from the system after being reset to defaults:*

1. Scan the USB HID barcode:

### **USB HID**

Scan the following code to program the scan engine for USB HID.



2. Scan the USB Keyboard barcode:

### **USB PC or Macintosh Keyboard**

Scan one of the following codes to program the scan engine for USB PC Keyboard or USB Macintosh Keyboard. Scanning these codes also adds a CR suffix.



3. Reconnect to the image engine using EZConfig-Scanning as shown on [page 25](#).

# Scan a Barcode

1. Point the tablet at the barcode.

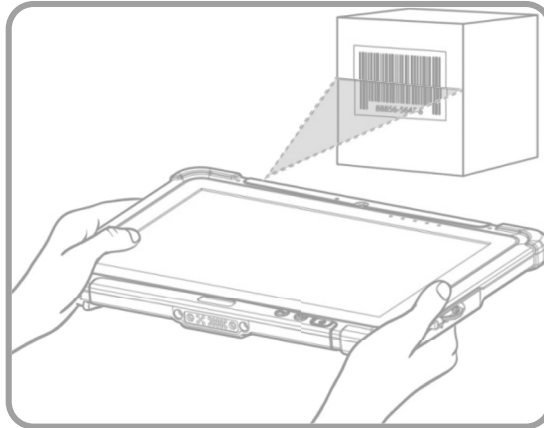

2. Press the Fn2 button. Center the aiming beam over the barcode.
3. Release the Fn2 button.

# USE THE CAMERA



Use this chapter to learn how to take pictures and record videos with the color camera.

## Color Camera

The RT10W contains an 8-megapixel color camera for taking pictures and videos. The camera and flash are located on the back of the tablet.

Use the **HotTabCam** app to view photos and videos stored on the RT10W.



## Enabling the Camera





1. Press the Menu button or double-tap .
2. Tap  **Device ON/OFF**.
3. Tap  **Camera** to toggle it on or off.  
Orange: the camera is on.  
White: the camera is off.

**Note:** If the camera is not enabled, the HotTabCam app will not open.



## Adjust the Camera and Video Settings

The camera and video settings are adjustable from within the **HotTabCam** app. You can change the camera settings for best results when taking pictures.

1. Double-tap  **HotTabCam** on the Home screen.  
OR  
Press the Menu button, then tap  **Camera**.
2. Tap  **Settings**.

3. Configure these settings:
  - **Photo Format:** the aspect ratio of the photo or video. The default is 4:3.
  - **Rear Video Resolution:** the resolution, in pixels, of videos taken with the rear-facing camera. The default is 3264 x 1836.
  - **Picture Quality:** Best (default), High, Medium or Low.
  - **File Location:** where photos and videos are stored. The default location is C:\Webcam.
4. Tap  to adjust the flash settings:
  -  - Flash is on
  -  - Flash is in automatic mode
  -  - Flash is off
5. To switch between the rear-facing camera and the front-facing webcam, tap .

## Take a Photo

1. Ensure the camera is on (see [Enabling the Camera](#) on page 29).
2. Double-tap  **HotTabCam** on the Home screen.  
OR  
Press the Menu button, then tap  **Camera**.
3. Using the screen as a viewfinder, move the computer until you see the image you want to capture.
4. Tap the screen to set the focus.
5. Tap  **Shutter** to take a picture. T
  - To view the picture in File Explorer, tap the thumbnail image above **Review** in the lower left corner.
  - To return to the **HotTabCam** app, close File Explorer.





## Record a Video



1. Ensure the camera is on (see [Enabling the Camera](#) on page 29).
2. Double-tap  **HotTabCam** on the Home screen.

OR

Press the Menu button, then tap  **Camera**.

3. Using the screen as a viewfinder, move the computer until you see the image you want to capture.
4. Tap the screen to set the focus.
5. Tap  **Video Record** to begin recording.

While a video is recording, the icon changes to a red circle .

6. To stop recording, tap  **Video Record**.
  - To view the video in File Explorer, tap  **Review**.
  - To return to the **HotTabCam** app, close File Explorer.



# CONFIGURE THE COMPUTER

Use this chapter to learn how to configure the RT10W. You will also find information on how to configure scanners, network communications and wireless security.

You configure Windows on the tablet using the Control Panel and the Settings app.

Standard Windows configuration options apply to the RT10W. Configuration options are located in the Control Panel or the Settings app.

## Windows Control Panel

The Control Panel contains icons for many configuration options, such as power options, blue tooth printing and scanning, and enterprise settings. The Control Panel icons are also used to add, delete or modify software installed on the RT10W.

To access the control panel, tap  > **Windows System** > **Control Panel**.

Most control panel applets on the RT10W are standard Microsoft Windows items. The functions listed below may differ from a standard Microsoft Windows equipped PC or laptop.

## About

Tap  > **Windows System** > **Control Panel** > **About** to view device-specific information.

## Software

### Firmware Versions

The **Software** tab lists the device serial number as well as firmware versions installed. The OEM tablet package, BIOS, and battery firmware versions are displayed on this tab.

## Language

The **Software** tab displays the localized language version of the OS image. The language is identified as English or + an additional language.

The RT10W Rugged Tablet User Guide may be preloaded with an English-only OS. Additional languages may be downloaded from the Microsoft Windows update site.

## Hardware

The Hardware tab displays information about the tablet's CPU, display, and dock (if applicable).

## Versions

The **Versions** tab displays the versions of many of the software programs installed. Not all installed software is included in this list, and the list varies depending on the applications loaded on the RT10W. The **OSVersion** line displays the revision of the system software installed. Refer to the last three digits to determine the revision level.

### Versions Tab and the Registry

The **Versions** tab displays program version details from the registry. Customized information can be displayed by modifying the Registry using the Registry Editor. Use caution when editing the Registry and make a backup copy of the registry before changes are made.

The registry settings for the **Versions** tab are under **HKEY\_LOCAL\_MACHINE \ Software \ HSM \ Version** in the registry. To add a user application to the Version panel, create a new string value under the **HKEY\_LOCAL\_MACHINE \ Software \ HSM \ Version** key. The string name should be the Application name to appear in the Version window. The data for the value should be the version number to appear in the Version window. Version strings can be equal to or less than 254 characters. Because the strings are displayed in a text box, any number can be accommodated, up to the 64K byte text box limitation.

## Network IP

### MAC Address

The **Network IP** tab displays the MAC address of the network card(s) such as the WLAN radio and the Bluetooth module.

## Bluetooth Printing

Tap  > **Windows System** > **Control Panel** > **Bluetooth Printing** (Large or Small Icon View).

To configure your computer for Bluetooth wireless printing, you need to:

- Create an application that opens the wireless printing COM port on your computer. For help, see the Bluetooth Resource Kit, which is part of the Intermec Developer Library (IDL), available from <https://hsmftp.honeywell.com>.
- Select the current wireless printer on your computer. For help, see the Printer Options section of [Enterprise Settings](#) on page 39.

**Note:** You can also print wirelessly using Microsoft APIs with Bluetooth extensions for Winsock and Bluetooth. For help, see the Bluetooth Resource Kit documentation.

The Bluetooth Printing wizard supports the following Honeywell printers:

- PR2
- PR3
- PB31
- PB21
- PB42
- PB50

To connect a printer using the search option:

1. Turn on the printer.
2. Select **Bluetooth Printing** from the control panel.
3. Select **Search** and tap **Acquire Printer**.
4. A list of available Bluetooth printers displays.

**Note:** Due to operating system limitations, other Bluetooth devices may not be filtered out from the printer listing.

5. If this is the first time a printer is connected, it may take 40-45 seconds for the driver to install.
6. If no error message displays, the printer is ready. If a printer authentication error message displays, the timeout may have happened before the driver installation completed.

To continue after an error:

- Dismiss the error.
  - Return to the Bluetooth Printing control panel and repeat the process starting with step 3.
7. The Bluetooth printer displays. Print a test page if desired.

## Bluetooth Scanning

Tap  > **Windows System** > **Control Panel** > **Bluetooth Scanning** (Large or Small Icon View)

There are several options to add a scanner:

- [Quick Connect](#) - Displays a barcode to be scanned by the desired Bluetooth scanner. The barcode displayed on screen only works for certain Bluetooth scanners. See [Quick Connect](#) below for details and supported scanners.
- [Search](#) - Initiates a search (discovery) of Bluetooth scanners within range. See [Search](#) on page 38 for details
- [Manual](#) - Prompts for entry of the Bluetooth scanner's MAC address. See [Manual](#) for details.
- Previous Devices - Displays a list of devices previously discovered Bluetooth scanners.

Some scanners are not supported via Bluetooth Scanning. To connect one of these scanners, see [Adding Other Scanners](#) on page 39.

If a scanner does not connect, see [Troubleshooting](#) on page 38 for help.

## Quick Connect

There are two different barcodes printed on decals on the side of the RT10W.

**Note:** *The barcodes below are samples. Do not scan these to connect a Bluetooth scanner. Scan the barcode on your device.*

LnkB00078006111AAA



LnkB Barcode Sample

Bluetooth Quick Connect 007806111AAA



Quick Connect Barcode Sample

## Using Quick Connect with Preprinted Labels

Scan the applicable barcode as indicated below:

Use the LnkB barcode on the back of the RT10W to connect the following scanners:

- Honeywell/LXE 8650 family of Bluetooth ring scanners
- Honeywell Granit 1911i Bluetooth scanner
- Honeywell Granit 1981i Bluetooth scanner
- LXE 88x0 family of Bluetooth scanners

Use the barcode Quick Connect barcode on either side of the RT10W to connect the following scanners:

- Intermec SF51 Bluetooth scanner
- Intermec SF61 Bluetooth scanner
- Intermec SR61 Bluetooth scanner

## Using Quick Connect with On-screen Barcode

1. Select **Bluetooth Scanning** from the Control Panel (either large or small icon view option must be selected).
2. Tap **Add Device**.
3. Select **Quick Connect** (incoming).
4. Tap **Next**.
5. Select the type of scanner to add:

**Note:** *If this choice is not presented, the on-screen barcode displayed is only valid for SF51, SF61 or SR61 barcode scanners.*

Select Granit 2D scanner to:

Display this barcode

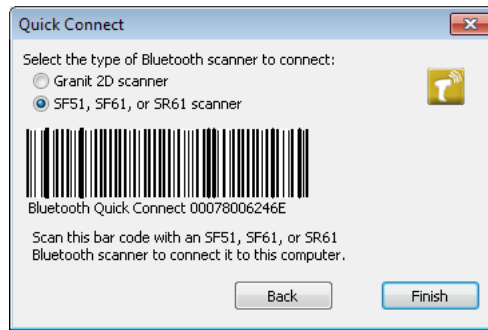

Scan the displayed barcode to connect one of these scanners:

- Honeywell/LXE 8650 family of Bluetooth ring scanners
- Honeywell Granit 1911i Bluetooth scanner
- Honeywell Granit 1981i Bluetooth scanner
- LXE 88x0 family of Bluetooth scanners

Select SF51, SF61 or SR61 scanner to:

Display this barcode

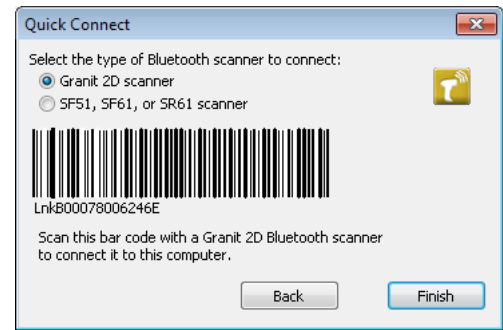

Scan the displayed barcode to connect one of these scanners:

- Intermec SF51 Bluetooth scanner
- Intermec SF61 Bluetooth scanner
- Intermec SR61 Bluetooth scanner

**Note:** *Not all barcode scanners can read the barcode from the screen. If this process fails, use the printed label on the device. See [Using Quick Connect with Preprinted Labels](#) on page 36.*

## Search

To search for a Bluetooth scanner:

1. Select **Bluetooth Scanning** from the Control Panel (either large or small icon view option must be selected).
2. Tap **Add Device**.
3. Select **Search**.
4. Tap **Next**.
5. Select the scanner from the devices shown.
6. Tap **Next**.

## Manual

1. Select **Bluetooth Scanning** from the Control Panel (either large or small icon view option must be selected).
2. Tap **Add Device**.
3. Select **Manual**.
4. Tap **Next**.
5. Enter the MAC address of the Bluetooth scanner.
6. Tap **Next**.

## Troubleshooting

- The Honeywell Xenon 1902 Bluetooth scanner does not work with Quick Connect. It must be connected using the Search or Manual options.
- Make sure the scanner is in the correct mode. Barcodes to set the mode can be found in the manual provided with the Bluetooth scanner.
  - The scanner must be a master device to use the Quick Connect option.
  - The scanner must be a slave device to use the Search or Manual option.
- The Motorola/Symbol LS3578 family of scanners may not support the Quick Connect feature (depending on firmware installed). If Quick Connect does not work, use the other options to connect these scanners.
- If the Honeywell Granit 1911i and Granit 1981i scanners cannot be found with the Search option, scan the PDAs/Mobility Systems Devices barcode from the scanner manual and search again.
- If the Honeywell Granit 1911i and Granit 1981i scanners cannot connect using the manual option, scan the PDAs/Mobility Systems Devices barcode from the scanner manual then repeat the manual add process again.



- If the Honeywell Granit 1911i and Granit 1981i scanners are not removed after using the Remove option, the auto-reconnect option is enabled on the Granit scanner (this is the default option). To remove the scanner:
  - Scan the disable auto-reconnect barcode from the Granit scanner manual then tap Remove, or
  - Scan BT\_RMV to unlink and disconnect the scanner then tap Remove.
- If a Honeywell/LXE ring scanner is not connecting, scan the **Restore Factory Defaults** barcode in the scanner manual and try connecting again.

## Adding Other Scanners

Some scanners may not be supported/discoverable by Bluetooth Scanning. In this case, use the Microsoft Bluetooth panels to add the scanner.

**Note:** *The Microsoft Bluetooth panels should only be used when the scanner cannot be connected with one of the methods listed above.*

## Enterprise Settings

Tap  > **Windows System** > **Control Panel** > **Enterprise Settings** (Large or Small Icon View)

Use Enterprise Settings to configure parameters for Enterprise applications on the computer. You can configure parameters for important functions like data collection and communications.

External barcode scanners are supported by connecting the scanner to a COM port, USB port, or by Bluetooth. The scanners parameters, including barcode symbologies, can be configured using **Enterprise Settings** > **Data Collection**.

## About the Structure of Enterprise Settings

Use the tables below to help find the parameters in Enterprise Settings that you want to configure. Each table contains the parameters for one of the Enterprise Settings Main Menu options.

If you see > next to a menu option, there are more screens available in the next level. If you see ... next to a menu option, there is only one more screen available.

Most parameters are saved as soon as you tap **OK**. Some settings require you to reboot the computer for the changes to take effect.

Data Collection	Parameters
Internal Scanner	<ul style="list-style-type: none"> <li>• Enable scanner port (On by default)</li> <li>• Symbologies</li> <li>• Symbology Options</li> <li>• Scanner Settings</li> <li>• Decode Security</li> </ul>

Data Collection	Parameters
<b>Tethered Scanners</b>	
Tethered/USB-Configure on Connect	Auto-configure on connect: <ul style="list-style-type: none"> <li>• Overwrite with computer settings (default)</li> <li>• Keep scanner settings</li> </ul>
Enable USB Scanner Auto Detect	Off (default)
Tethered Scanner (COM1)	<ul style="list-style-type: none"> <li>• Enable scanner port (On by default, see note below)</li> <li>• Symbologies</li> <li>• Symbology Options</li> <li>• Scanner Settings</li> <li>• Scanner Port Settings</li> <li>• Decode Security</li> </ul>
Tethered Scanner (COM 2)	<ul style="list-style-type: none"> <li>• Enable scanner port (On by default, see note below)</li> <li>• Symbologies</li> <li>• Symbology Options</li> <li>• Scanner Settings</li> <li>• Scanner Port Settings</li> <li>• Decode Security</li> </ul>
<p><b>Note:</b> By default, COM1 and COM2 are enabled as scanner ports. To use the COM port for another use (such as screen blanking), set <b>Enable Scanner Port</b> to <b>Off</b> for the desired port.</p> <p><b>Note:</b> Symbology configuration is supported on Intermec scanners. For all other scanners use the barcodes provided in the scanner manuals to program the symbologies.</p> <p><b>Note:</b> Do not select ASCII as the scanner model for an Intermec scanner or the ability to configure the symbology settings with Enterprise Settings is lost.</p>	
<b>Bluetooth Scanners</b>	
BT-Configure on Connect	Auto-configure on connect: <ul style="list-style-type: none"> <li>• Overwrite with computer settings</li> <li>• Keep scanner settings</li> </ul>

Bluetooth	Parameters
Power	<ul style="list-style-type: none"> <li>• Off</li> <li>• On (default)</li> </ul>
Class of Device	Hardware information (no user entry)
IBT	Hardware information (no user entry)
Radio	Hardware information (no user entry)
Device Address	Hardware information (no user entry)

<b>Applications</b>	<b>Parameters</b>
Launcher	<ul style="list-style-type: none"> <li>• Program Version</li> <li>• Application Launch Buttons <ul style="list-style-type: none"> <li>• Caption Text Color</li> <li>• Application Button 1 - 21</li> </ul> </li> <li>• Background Image</li> <li>• Single Application Auto Start</li> <li>• Restricted File Browser</li> <li>• Default Password</li> <li>• Whitelist</li> <li>• Appearance</li> <li>• MenuOptions</li> </ul>
Auto Start	Auto Start Options <ul style="list-style-type: none"> <li>• None (default)</li> <li>• Launcher</li> <li>• Enterprise Browser</li> </ul>
Enterprise Browser	<ul style="list-style-type: none"> <li>• Browser Engine</li> <li>• General</li> <li>• Menu Options</li> <li>• Security</li> <li>• Privacy</li> <li>• Appearance</li> <li>• Menu and Toolbar Actions</li> </ul>

<b>Printers</b>	<b>Parameters</b>
Printer Options	If connected through Bluetooth Printing, configuration options Connect Printer and Refresh are available.

<b>License Manager</b>	<b>Parameters</b>
License Vault	None (displays applications that are licensed)

<b>SmartSystem Information</b>	<b>Parameters</b>
Identity	Identity information (hardware version, firmware version, OS version, etc.) (read-only)
Administrator	Administrator settings (name, phone, and email)
Location	Location settings (country, state, city, campus, and detail)
Information	Device Notes (read-only)

<b>Core Messaging Service</b>	<b>Parameters</b>
Server IP	Server IP (read-only)
Broadcast Name	Broadcast Name
Port	Port (read-only)

Core Messaging Service	Parameters
Keep Alive Ping Interval	Keep alive ping interval

Common Lockdown Service	Parameters
CLDS Server	<ul style="list-style-type: none"> <li>• Server <ul style="list-style-type: none"> <li>• Port</li> <li>• Maximum Client Connections</li> <li>• Enable Server</li> </ul> </li> <li>• Lockable Keys <ul style="list-style-type: none"> <li>• Lock Windows key</li> <li>• Lock Task Manager key</li> <li>• Lock Task Switcher key</li> <li>• Lock Windows Security Dialog key</li> <li>• Lock Closing Applications key</li> <li>• Lock Minimize key</li> <li>• Lock New Session key</li> </ul> </li> </ul> <p><b>Note:</b> <i>The Windows key may not display the Windows Start menu. This is a limitation of the Windows 10 operating system.</i></p>

Virtual Wedge	Parameters
Enable Virtual Wedge	Enable virtual wedge
Virtual Wedge Method	<ul style="list-style-type: none"> <li>• Adapt to Application (default)</li> <li>• Character mode</li> <li>• Block mode</li> </ul>
Barcode Scanner Wedge	<ul style="list-style-type: none"> <li>• Barcode Scanner Grid</li> <li>• Label Encoding (Code Page)</li> </ul>

## How to Navigate in Enterprise Settings

You can easily navigate through the screens in Enterprise Settings to find the parameters you need to configure. Three dots (...) or an arrow (>) next to a menu item indicates one or more configuration screens are available.

- Tap a menu item to access settings.
- Tap inside a text field to enable text entry.
- Tap a field (radio button or box) to toggle a selection on or off.
- Use the up and down arrow keys to move up and down the menu.
- To move back a level in the menu, tap **Back** or **Cancel** on the Tile bar.
- To exit Enterprise Settings, tap **Menu > Exit** or **OK**.

## How to Restore Enterprise Setting Defaults

You can restore all default Enterprise settings or restore default settings for only a specific menu item in Enterprise Settings.

**Note:** *When you restore default settings, only the settings for visible menu items are restored. The settings for hidden menu items are not affected.*

### Restore Default Settings to a Single Menu

You can restore default settings for a specific menu item in Enterprise Settings.

1. Start **Enterprise Settings**.
2. Navigate to the menu that you want to restore to defaults.
3. Tap **Menu > Restore Menu Defaults**.
4. When prompted, tap **Yes** to restore the menu default settings.
5. If prompted to refresh the computer, tap **Yes**.

### Restore Default Settings to All Parameters

You can restore all Enterprise Settings parameters to their default settings.

**Note:** *The Restore All Defaults option is recommended only when the RT10W is used with a vehicle dock.*

1. Start Enterprise Settings.
2. Tap **Menu > Restore All Defaults**. The application asks if you are sure you want to restore all defaults.
3. When prompted, tap **Yes** to restore all default settings.

After several minutes, all of the default settings are restored.

4. If prompted to refresh the computer, tap **Yes**.

## How to Hide Menu Items in Enterprise Settings

You can hide items in the Enterprise Settings menus if you do not want to have them available for other users to access.

**Note:** *When you restore default settings in Enterprise Settings, only the settings for visible items are restored to defaults. The settings for hidden menu items are not affected.*

### Hide Menu Item

1. Start **Enterprise Settings**.
2. Tap and hold the item you want to hide.
3. Select **Hide Menu Item** from the popup list.
4. Tap **Yes** to confirm.

## Restore All Hidden Menu Items

1. Start **Enterprise Settings**.
2. Tap **Menu** > **Unhide All Items**.

## Barcode Scanners and Enterprise Settings

The following types of barcode scanners are supported on the RT10W:

- A tethered scanner connected to COM1 or COM2
- A tethered scanner connected to a USB host port
- A wireless scanner connected via Bluetooth

The scanner symbologies can be updated through Enterprise data collection software.

## Serial Scanners

**Note:** *When your tablet is docked, ensure a tethered scanner is properly connected before attempting to scan.*

To configure a particular scanner to work with Enterprise data collection software, tap  > **Windows System** > **Control Panel** > **Enterprise Settings** > **Data Collection** > **Tethered Scanner** > **Tethered Scanner (COM1)** or **(COM2)** > **Scanner Settings**.

Select the appropriate scanner model (SR Intermec Scanner, ASCII, SR60). By default, both COM1 and COM2 are opened so the appropriate scanners (see below) can work without changing factory defaults:

### Tethered Scanner (COM1)

By default the Scanner Model is set to SR Intermec Scanner, which covers models such as SR61T, SR30, and SR31. This COM port's settings are designed to work with legacy Intermec scanners.

### Tethered Scanner (COM2)

By default the Scanner Model is set to ASCII to connect with a scanner with baud rate of 9600, 8 data bits, no parity, 1 stopbit, and no flow control. This COM port's settings are designed to work with most legacy Honeywell and LXE scanners.

## USB Scanners

By default, when a HID enabled USB scanner is connected to the RT10W, the scanned data is transmitted to the active windows as keystroke messages. Any data handling to be applied to the scanned data, for example to strip leading or trailing characters, must be programmed into the scan engine. This is done by scanning configuration barcodes from the scanner manufacturer or handled by the application accepting the data.

For the RT10W, the USB Intermec SR61T and SR31 may be set up to be configurable through Enterprise Settings. This can be done by setting Enable USB Scanner Auto-detect to On under the Data collection menu. If the USB scanner is already attached, you must detach and then re-attach it after USB Scanner Auto-detect is enabled in order for it to be recognized by Enterprise Settings. Refresh the Enterprise Settings screen to see the connected USB scanner.

## Bluetooth Scanners

See [Bluetooth Scanning](#) on page 35 for information on connecting Bluetooth scanners.

Always use Enterprise Settings to configure Bluetooth parameters. Do not use the Bluetooth configuration options available from the Bluetooth icon in the system tray.

## Options

Tap  > **All Apps** > **Windows System** > **Control Panel** > **Options** (Large or Small Icon View).

### 5V on COM1

By default, Pin 9 of COM1 provides +5V, such as for an external scanner tethered to the COM1 port. Uncheck this box to configure Pin 9 of COM1 to provide RI.

### 5V on COM2

By default, Pin 9 of COM2 provides +5V, such as for an external scanner tethered to the COM2 port. Uncheck this box to configure Pin 9 of COM2 to provide RI.

## Sounds

Tap  > **All Apps** > **Windows System** > **Control Panel** > **Sounds** (Large or Small Icon View).

Use the slider bar to adjust the volume level as desired.

Alternatively:

- Tap the Volume icon, if present, in the taskbar and move the slider until the volume level is as desired.
- Use the integrated keypad - press the **Blue** key then **P1** to adjust volume up or **Blue** then **P2** to adjust volume down.
- By default the side tone is muted. If needed, the user should enable the side tone. If this causes interfering noise, the side tone should be disabled. The RT10W audio is designed to be used with or without the side tone. This is acceptable permissible performance for the RT10W.

# ZoomZone

Tap  > **Windows System** > **Control Panel** > **ZoomZone**, or tap the ZoomZone icon in the system tray.

ZoomZone can be used to configure screen blanking behavior when a tablet is in a vehicle dock and a blanking box is attached.

## Motion Detection Action

Determine what to do when motion is detected:

- **Display Always Active** - The display does not change when motion is detected.
- **Display Black** - The display is blacked out when motion is detected.
- **Display Freeze** - The display is frozen at the time motion is detected.
- **Use Zoom Area** - A preconfigured zoom area is displayed when motion is detected.

## Display Intensity

Displays the intensity (brightness) level of the display when the ZoomZone control panel was opened.

## Motion Detection Method

Select the motion detection method.

The RT10W supports the screen blanking box to determine motion. Select the port (COM1 or COM2) to which the blanking box is attached.

**Note:** *By default, COM1 and COM2 ports are used by Enterprise Data Collection. To use a COM port for screen blanking, access [Enterprise Settings](#) (page 39) and set **Data Collection > Tethered Scanners > Tethered Scanner (COMx) - Enable Scanner Port** to off (where COMx is either COM1 or COM2).*

## Motion Timeout Settings

Screen blanking can be configured to provide delays.

- **Delay on Motion** - Configure the delay between motion detection and screen blanking. The default is 2 seconds.
- **Delay on Stop** - Configure the delay between motion stopping and the screen resuming normal behavior. The default is 2 seconds.

## Configuration Storage

Select the users to which the ZoomZone settings apply.

- **Global Storage** - The ZoomZone settings apply to all users of the RT10W.



- **Per User Storage** - The ZoomZone settings only apply to the current user.

## Change password

By default, no password is assigned to ZoomZone. If a password is set, the password must be entered to access the ZoomZone user interface to view or change configuration parameters.

To set a password:

1. Tap the **Change Password** button.
2. Enter the current password. If no password is assigned, leave this entry blank.
3. Enter and confirm the new password. To remove a previously set password, leave the new password blank.
4. Tap **OK** to confirm changes or **Cancel** to discard changes.

## Set Zoom Area

The Zoom Area can be selected from the current active desktop display. To set the zoom area:

1. Display the desired content on the RT10W desktop.
2. Open the ZoomZone interface.
3. Tap the **Set Zoom Area** button.
4. Select the desired zoom area by tapping on the upper left corner of the desired area and dragging to the lower right corner of the desired area. The selected area is highlighted by a red outline.

**Note:** *Be sure to select the desired area from the upper left corner to the lower right. Selecting the area from a different corner may result in nothing (a black box) being displayed.*

5. If the selected area is not satisfactory, repeat the step above to reselect an area.
6. At the top of the display, tap **File** and select one of the available options:
  - **Save** - Saves the selected zoom area and returns to the ZoomZone user interface.
  - **Test** - Previews the zoom area as it would be displayed during screen blanking.
  - Tap **Accept Zoom** to keep the zoom area and finish, or
  - Tap **Reject Zoom** to discard the zoom area and be returned to select a different zoom area.
  - **Exit** - Discards changes and returns to the ZoomZone user interface.

## Show Zoom Area

Tap the **Show Zoom Area** button to show the currently selected zoom area. The selected area is highlighted in red.

When finished, at the top of the display tap **File > Exit** to exit.

To see how the zoom area would be displayed during screen blanking, see [Test Zoom Area](#).

## Test Zoom Area

Tap the **Test Zoom Area** button.

The zoom image is displayed.

When finished, at the top of the display tap **File > Exit** to exit.

# Windows Settings App

Use the Settings app to adjust time, date, language or volume level, or check for Windows updates. The Settings app is located in the Start menu.

To access the Settings app, tap  > .

## Structure of the Settings App

Use this section to learn about the structure of the Settings App so you can find parameters quickly.

Settings	Descriptions
System	Provides information about your RT10W and lets you set the brightness level, screen rotation, and battery saver settings.
Devices	Lets you configure Bluetooth settings, mouse, and USB connections as well as add printers and (external) scanners.
Phone	Let's you link a mobile phone to your tablet.
Network & wireless	Lets you configure your Wi-Fi network, turn on or off airplane mode, turn on a mobile hotspot, and configure cellular data usage.
Personalization	Lets you personalize the RT10W according to your needs. You can configure the theme, sounds, screen lock times, notifications, and more.
Apps	Lets you uninstall apps, choose default apps, and manage optional features.
Accounts	Lets you set up email, contacts, and workplace accounts.
Time & language	Lets you configure the date and time, language, region, and keyboard settings.
Ease of Access	Lets you configure the text size, contrast, zooming capability, and narration and speech settings for the RT10W.

Settings	Descriptions
Privacy	Lets you configure the privacy settings for your RT10W such as location.
Update & security	Lets you backup data to the cloud, check for updates, find your phone, and configure developer features.
Extras	Lets you configure extra information for the RT10W such as turn off display on face down. It also provides battery information.
Search	Lets you configure SafeSearch, Windows Cloud Search and search history preferences.

## User Accounts

Tap  >  > **Accounts**



If creating additional user accounts do not use # character (known as the number sign, pound sign, hash symbol, etc.) in the user account name.

**Note:** *The following applies to a RT10W that is not part of a domain. When the RT10W is part of a domain, the user is prompted for credentials at Windows startup or log on.*

The RT10W is preconfigured with an administrator account named Administrator. By default, the RT10W automatically logs onto the Administrator account at Windows startup.

If the user assigns a password to the Administrator account:



- The password is stored and used when the RT10W logs onto the Administrator account at Windows startup. The user is not prompted to enter a password.
- If the user logs off, the password must be manually entered to log back onto the RT10W.
- At the logon prompt, the user could specify a different user account (and password, if necessary) to log on, assuming the account has been added to the RT10W.
- When the RT10W is restarted, the Administrator account automatically becomes the active user account, regardless of the active account before the restart.

If using certificates for authentication, the user must assign a password to the active (Administrator) account.

## Set the Date, Time, or Time Zone

The tablet gets the current date and time from its network connection. You can manually set the date, time, and time zone for your location. The 24-hour clock is turned off by default. By default, the RT10 is set to automatically update the time and date for your current location. Use this procedure to manually set the date, time, or time zone.

To change date and time:

1. Tap .
2. Tap .
3. Tap **Time & Language > Date & Time.**
4. Tap the toggle box for **Set time automatically** to turn it off.
5. Tap **Change.**
6. Tap the **Date** and **Time** to set each one manually.
7. Tap **Change.**
8. To set the time zone, select the correct time zone from the drop down list.



## Region and Language

1. Tap .
2. Tap .
3. Tap **Time & Language > Region & Language.**

To add a language, there must be Internet access available to access the Windows update site.

1. Tap **Add a language.**
2. A list of available languages is displayed. Tap the desired language.
3. The selected language is now shown below **Add a language.** Note that “Searching Windows Update” and then “Language pack available” is shown below the new language.
4. Tap the new language.
5. Tap **Options.**
6. Tap the **Download** button under Download language pack.
7. When the download and installation are completed, the language pack installed is displayed.
8. Tap the back arrow at the top left of the screen.
9. Tap the new language again.
10. Tap **Set as default.**
11. Restart the RT10W.

## Check for Windows Updates

1. Tap .
2. Tap .
3. Tap **Update & Security**.
4. If the **Check for Update** check box is already enabled, the software status will display. If is not enabled, tap the box and the RT10W will verify whether the tablet has the most recent software version.

## Barcode Readers

The RT10W can use the following external barcode readers:

- Tethered hand-held scanners are tethered to a serial port or a USB host port (via a dongle cable) on the RT10W dock and are configured by scanning the engine-specific barcodes in the scanner manufacturer's programming guide. The manufacturer's guides are usually shipped with the barcode reader.
- Wireless hand-held Bluetooth scanners are configured by scanning the engine-specific barcodes in the scanner manufacturer's programming guide. The manufacturer's guides are usually shipped with the barcode reader.
- The body worn Bluetooth Ring Scanner module may be using a Symbol 4400 Ring Imager or a Symbol 955 Ring Scanner. The BTRS module is configured by scanning the barcodes in the Bluetooth Ring Scanner Guide.

## Scanner (Virtual) Wedge

Virtual wedge parameters are set via [Enterprise Settings](#) on page 39.

## Network Communications

You can use the mobile computer in your wireless or wired data collection network. You can connect your computer using:

- 802.11 radio communications
- Ethernet communications
- Bluetooth communications
- USB and serial communications

## View Network Information

1. Tap .
2. Tap .
3. Tap **Network & Internet**.

## Connect to a Wi-Fi Network

The RT10W has an 802.11 radio to transfer data using wireless communications. Before you connect to a Wi-Fi network, you need to know about your network security protocol and its required credentials. By default, the 802.11 radio is disabled.



When a Wi-Fi connection is active, you can view connection information or edit the networks settings by selecting the network name on the Wi-Fi Settings screen.

1. Tap  in the Windows taskbar. A list of available networks displays.
2. Tap a network name to select it.
3. Tap **Connect**.

If the network is secured, a list of required information displays (such as a security key). To connect to the secured network, enter the required information and tap **Next**.

## Connect to a Hidden Wi-Fi Network



For security reasons, some networks do not appear on the available network list even if you are in range.

1. Tap .
2. Tap .
3. Tap **Network & Internet > Wi-Fi**.
4. Tap the toggle box to turn on Wi-Fi. A list of discovered networks displays.
5. Tap **Manage known networks**.
6. Tap **Add a new network**.
7. Enter the **Network name**. Network names are case-sensitive.
8. Select a security type from the drop-down list.
9. If the network is secure, you will be asked to provide information relevant to the network security protocol such as a password, key, or certificate. Type the required information

10. Click **Connect even if this network is not broadcasting**.
11. Tap **Save**.



## Modify Channel Settings

You can manually select the channels the 802.11 radio uses for communication.

1. Tap .
2. Tap .
3. Tap **Network & Internet > Wi-Fi**.
4. Tap **Change adapter options**.
5. Double-tap your Wi-Fi adapter.
6. Select **Properties > Configure > Advanced**.
7. Under **Property**, select 802.11a/b/g Wireless Mode.
8. From the **Value** drop-down list, select the desired band.
9. Tap **OK**.
10. Tap **Close**.

## Change Roaming Settings

In Windows 10 the Wi-Fi radio automatically roams from one access point to another as needed to provide seamless connectivity. To change the sensitivity of Wi-Fi roaming:

1. Tap .
2. Tap .
3. Tap **Network & Internet > Wi-Fi**.
4. Tap **Change adapter options**.
5. Double-tap your Wi-Fi adapter.
6. Select **Properties > Configure > Advanced**.
7. Under **Property**, select **Roaming Aggressiveness**.
8. From the **Value** drop-down list, select the desired level of roaming aggressiveness.
9. Tap **OK**.
10. Tap **Close**.

## Connect to an Ethernet Network

By default, the RT10W is configured to obtain IP addresses automatically through the DHCP server. In most cases, you can simply insert the RT10W into an Ethernet dock and connect to the Ethernet network. To connect the computer to an Ethernet network, you need an Ethernet dock.



1. Make sure the dock is connected to your Ethernet network.
2. Place the computer in the dock.

## How to Connect to Virtual Private Networks

The computer supports connecting to virtual private networks (VPNs). To configure VPN access, you must obtain details from your network administrator. To establish a VPN connection, you must first create a VPN profile on the RT10W.

### Add a VPN Profile

Before you can connect to a VPN, you must add VPN information.

1. Tap .
2. Tap .
3. Tap **Network & Internet > VPN**.
4. Tap **Add a VPN Connection**.
5. From the VPN provider box, select a provider from the drop-down list.

**Note:** A VPN service provider will display in the drop-down list only if you have already downloaded and installed that service provider's app from the Windows Store.

6. Enter a **Connection** name.
7. In the **Server name or address box**, type the server name or IP address of the VPN server.
8. In the VPN type box, choose one of the following:
  - Point to Point Tunneling Protocol (PPTP)
  - L2TP/IPsec with certificate
  - L2TP/IPsec with pre-shared key
  - Secure Socket Tunneling Protocol (SSTP)
  - IKEv2
9. Select the **Type** of sign-in info required to connect to the VPN server and then enter the required information.
10. Optional: Type a **User Name** and **Password**.
11. Tap **Save**. The VPN connection displays on the screen.



# Wireless Security

The computer provides these security solutions for your wireless network:

- Wi-Fi Protected Access 2 (WPA2™)
- Wi-Fi Protected Access (WPA)
- 802.1x
- LEAP
- WEP

Honeywell recommends WPA2 security with PSK (Personal) or 802.1x (Enterprise) key management.

Before you set security, you need to enable the radio, set the date, and set the SSID on your computer. To use 802.1x security, you need to load a root certificate on your computer. To use transport layer security (TLS) with 802.1x security, you also need to load a user certificate.

Use the Settings App to access and configure all wireless security settings.

## Certificates

The RT10W allows you to install digital certificates for secure client communications with websites and services. You can install certificates through Microsoft Edge, email, or mobile device management (MDM). Once you install a certificate, you can use it to set up your VPN profiles, Wi-Fi, and email accounts. You can only remove a certificate if you restart the computer. For help, see [Restart the Tablet](#) on page 60.

## Install a Certificate with Microsoft Edge

Some certificates are posted and made available for download through a device-accessible URL.

1. Type the URL in the Microsoft Edge address bar.
2. Select the certificate. It opens on the RT10W.
3. When prompted, select to install the certificate.

## Install a Certificate with Email

The Windows 10 Mobile certificate installer supports .cer, .p7b, .pem, and .pfx files.

1. Open the email with the encrypted certificate file attached.
2. Save the file to the RT10W.
3. Select the file to open it and choose install.

4. Type any security information required.

## Install a Certificate with MDM

Administrators can use Mobile Device Management (MDM) software to add root and CA certificates or configure the RT10W to enroll a client certificate with an enrollment server that supports Simple Certificate Enrollment Protocol (SCEP) used for certificate based client authentication (such as Wi-Fi, VPN, or email). To learn how to install certificates with MDM, go to <https://technet.microsoft.com/en-us/itpro/windows/keep-secure/installing-digital-certificates-on-windows-10-mobile>.

## Bluetooth Communications



The RT10 is Bluetooth-enabled, which lets you connect to other Bluetooth devices. You need to turn on the Bluetooth radio before you can discover and connect to other Bluetooth devices. By default, the radio is turned off.

The Bluetooth radio maintains its current state through a system reset. If you perform a factory data reset, you must recreate pairings to devices.

## Connect a Bluetooth Device

To connect to a Bluetooth device, you must enable Bluetooth and then select the device from a list of discovered devices.



**Note:** *If you are attempting to connect to a printer or a headset, the default PIN may be 1234 or 0000. If neither of these PIN numbers work, consult the device documentation for the PIN number.*

1. Tap .
2. Tap .
3. Tap **Devices > Bluetooth & other devices**.
4. Tap the toggle to turn on Bluetooth.
5. Tap **Add Bluetooth or other device**.
6. Tap **Bluetooth**. A list of discoverable Bluetooth devices displays.
7. Tap the name of the device you want to pair with the RT10.
8. If the device requires a pin, do one of the following:
  - Compare the pin displayed on both the computer and other device. If they match, select **Connect**.
  - Enter the pin for the device and then select **Done**.

9. When the devices are paired successfully, “paired” displays under the device name.

## Disconnect a Paired Device

You can disconnect a paired Bluetooth device from the Settings App.

1. Tap .
2. Tap .
3. Tap **Devices > Bluetooth & other devices**.
4. Scroll down to **Other devices**.
5. Tap and the name of the paired device to select it.
6. Tap **Remove Device**.
7. Tap **Yes** to confirm.

## Serial and USB Communications

You can use accessories to transmit data to and receive data from another device through serial or USB communications. For information on available RT10W accessories, contact your local sales representative.

## Developer Information

To download the SDK for the RT10W:

1. Go to the Honeywell Technical Support Downloads Portal at <https://hsmftp.honeywell.com>.
2. Create an account if you have not already created one. You must login to download the software.
3. Install the *Honeywell Download Manager* tool on your workstation (e.g., laptop or desktop computer) prior to trying to download any files.
4. Click on **Software > Software and Tools > Developer Library**.
5. Navigate to the RT10W.
6. Select **Download** next to the software zip file.



# MANAGE AND MAINTAIN THE RT10W

Use this chapter to understand how to update software, perform troubleshooting, and maintain the RT10W.

## About Software Updates

Cyber security best practices include keeping your device apps and OS up to date. To help, Honeywell offers maintenance patches, security updates and operating system upgrades through our Honeywell Edge services.

Availability and cost depend on the following:

- Date of purchase of the device or software app.
- Warranty status.
- Service agreement status (devices) or Maintenance plan status (apps).

To learn more about Honeywell Edge Services, go to [sps.honeywell.com/us/en/services/productivity/support-services](https://sps.honeywell.com/us/en/services/productivity/support-services).



**Honeywell recommends routinely checking [honeywell.com/SPS-cyber-security](https://honeywell.com/SPS-cyber-security) for critical Cyber Security Notifications and to download the latest Network and Security Guides.**

## Software Downloads

Product support is available online through [Technical Support](#). Software updates can be accessed through the [Software Downloads](#) portal. You will need to create a login account for portal access. Additional information such as purchased date, service agreement number, maintenance plan number, or software license number may be required for downloads.

1. Go to [honeywell.com/PSSsoftware-downloads](https://honeywell.com/PSSsoftware-downloads).
2. Create a login account if you have not already created one.
3. Install the Honeywell Download Manager tool. See “Note” on the portal page. This tool is required for downloads.

4. Locate the app or upgrade you want to download in the Software directory.
5. If prompted, enter additional information, and click **Submit**.
6. Select **Download**. Follow the prompts to download the file.

## View Network Adapter Information

The IPConfig app displays, releases, and renews IP parameters for on-board network adapters. Use IPConfig to view information on the network adapters including the MAC address, IP address, netmask, gateway, and DHCP settings.

1. Tap .
2. Tap **Windows System > Command Prompt**.
3. Enter “ipconfig”.

## How to Restart the Tablet



If the computer or an application locks up, or if the computer does not respond when you press the **Power** button, you may need to restart the computer.

The computer uses the configuration currently saved in flash memory during the boot process. Try these methods, in order, to restart the computer:

- **Restart:** Restarts the tablet and goes through the full initialization process.
- **Restart in Safe Mode:** Restarts the tablet with limited files and drivers.
- **Reset:** Returns the tablet to the factory default state.

## Restart the Tablet

You may need to restart the tablet to correct conditions where an application stops responding to the system.



1. Save your files and close any open applications.
2. Tap .
3. Tap .
4. Select **Restart**.

If the touch screen is unresponsive:

- Press and hold the **Power** button for approximately 6 seconds to turn the tablet off.

## Restart in Safe Mode

If rebooting the tablet did not work, restart in safe mode to get the computer up and running for further troubleshooting. Safe mode allows you to start the tablet with limited drivers, apps and processes.

1. Tap .
2. Tap .
3. Tap **Update & Security > Recovery > Restart now.**
4. Tap **Troubleshoot >Advanced options.**
5. Select **Startup Settings.** (If that option is not displayed, click **See more recovery options.**)
6. Tap **Restart.**
7. After the tablet restarts, tap anywhere on the screen to access the keyboard.
8. Select 4 (or F4) to start in Safe Mode, or 5 (or F5) for Safe Mode with Networking.

## Reset the Tablet to Factory Default State

The RT10W tablet has a dedicated recovery partition stored on the hard drive of the tablet to enable quick one-key recovery process. This partition occupies about 11GB of the storage space.



**Caution: Before starting the recovery process, be sure to back up all user data, as all personal files will be lost after the recovery process.**

To enable quick one-key recovery procedure and initiate the Recovery Wizard:

1. Plug the AC adapter into the RT10W. Make sure the tablet stays plugged into a power source during the recovery process.
2. Power on the RT10W.
3. When the Honeywell splash screen displays, press and release the Fn1 button to start the Recovery Wizard or, if using an external USB keyboard, press F6.
4. Tap **Recovery.**
5. Tap **Yes.**

A command prompt displays the progress of the recovery message. This process may take several minutes.

6. Once the recovery process completes:

If you do not have an external keyboard, the RT10W will turn off automatically after a few minutes.

If you have an external keyboard attached, press any key to continue when prompted, and the RT10W will turn off.

## Recover or Update Windows OS

The steps for updating the RT10W operating system with a Honeywell-provided .iso file are the same as recovering Windows with an .iso file. (Refer to the previous section for information on the one-key recovery process to restore factory defaults.)

### Requirements

- USB hub or RT10 desk dock
- USB keyboard
- Empty USB thumb drive with at least 16GB storage
- Third-party software for creating a bootable USB drive



**Caution:** Before starting the recovery process, be sure to back up all user data, as all personal files will be lost after the recovery process.

### Installation

1. Download the latest Windows 10 ISO image for the RT10W from the Technical Support Downloads Portal (see [About Software Updates](#) on page 59.)
2. Create a bootable USB thumb drive with the ISO image.

**Note:** You will need a third-party software tool to create a bootable drive. Copying the ISO file or its contents to the USB drive is not sufficient.

3. Rename the USB drive's name "RDVD"
4. If using a hub, plug it into the tablet.  
If using a dock, insert the tablet.
5. Connect the keyboard and USB drive to the hub or dock.



**Caution:** Ensure the RT10W remains connected to the hub or dock and a power source until the recovery process is finished.

6. Turn on the RT10W.
7. Press the **ESC** key while the RT10W is powering up to display the configuration menu.
8. Use the keyboard arrow keys to select **Boot Manager**
9. Press **Enter**.



10. Select the bootable USB drive “EFI USB Device (*manufacturer name*)”.
11. Press **Enter**.  
After a few moments, the tablet restarts.
12. Once the Recovery Wizard displays, touch **Recovery**.  
A warning message displays.
13. Verify your files are backed up, then touch **Yes**.  
A command window displays the recovery progress.
14. When prompted, press any key to shut down the tablet and complete the recovery process.

## Use PXE Boot to Load an Operating System

The RT10W supports PXE boot. The following are required for PXE boot:

- A server containing the installation files.
- A wired connection from the server to the RT10W.

To use the PXE boot feature:

1. Start the RT10W.
2. When the Honeywell splash screen displays, press and hold the Menu button or, if using an external USB keyboard, press F7.
3. The RT10W connects to the PXE server via IPv4 and boots from the server.
4. If the server is not found with 30 seconds, the RT10W proceeds to the default boot method.

## Repairs

Repairs and/or upgrades are not to be performed on this product. These services are to be performed only by an authorized service center (see [Customer Support](#) on page vii).

## Maintenance

Your device provides reliable and efficient operation with a minimum of care. Although specific maintenance is not required, the following section describes periodic checks to ensure dependable operation.

## Clean the Tablet

The tablet housing, scanner window, camera window and touch screen may be cleaned with a soft cloth dampened with water. The touch screen may also be cleaned with a soft cloth dampened with isopropyl alcohol 70%.

**Note:** *Reading performance may degrade if the scanner window is not clean. If the window is visibly dirty, or if the scanner is not operating well, clean the window.*



**Caution:** **Do not submerge the tablet in water. Do not use abrasive wipes or cloths on the windows or touch screen. Abrasive wipes may scratch the windows and touch screen. Never use solvents (e.g., acetone) on the housing or windows. Solvents may damage the tablet finish, the windows or touch screen.**

**Caution:** **Ensure all components are dry prior to mating the tablet with charging accessories or other peripheral devices. Mating wet components may cause damage not covered by the warranty.**

## Computer Agency Information

RT10W Rugged Tablets meet or exceed the requirements of all applicable standards organizations for safe operation. The best way to ensure safe operation is to use the mobile computer according to the agency guidelines on the product regulatory sheet, quick start guide, battery insert and in this user guide. Read all guidelines before using your computer.

Product documentation is available for download from [sps.honeywell.com](https://sps.honeywell.com).

Public certificates are available for download from [honeywell.com/PSScompliance](https://honeywell.com/PSScompliance).

## Label Locations

Labels inside the battery compartment contain information about the tablet including, compliance information, model number, serial number and MAC address. Laser safety labeling is located on the back of the tablet.

## Physical and Environmental Specifications

1. Go to [sps.honeywell.com](https://sps.honeywell.com).
2. Type RT10W in the Search box and then press **Enter**.
3. Click on the product link in the search results.
4. Select one of the following tabs:
  - **Specifications**  
View System Architecture, Wireless Connectivity, Mechanical, and Environmental specifications.

- **Resources**

View and download available product documentation. For example, Data Sheet, Accessory Guide, Quick Start Guide, User Guide, Regulatory Information, Battery Information.

## Barcode Symbologies Supported

The computer supports the following barcode symbologies:

1D Symbologies		2D Symbologies		Postal Codes	
	Default		Default		Default
Codabar	Enabled	Aztec Code	Enabled	Australian Post	Disabled
Code 39	Enabled	Codablock A	Disabled	China Post	Disabled
Code 11	Disabled	Codablock F	Disabled	Korean Post	Disabled
Code 93	Enabled	DataMatrix	Enabled	2D Postal Settings	Disabled
Code 128	Enabled	HanXin	Disabled	Planet Code	Disabled
Composite	Disabled	Maxicode	Disabled	Postnet	Disabled
EAN/JAN-8	Enabled	Micro PDF 417	Enabled		
EAN/JAN-13	Enabled	PDF 417	Enabled		
GS1-DataBar Limited	Enabled	QR Code	Enabled		
GS1 DataBar Omni-Directional	Enabled				
GS1 DataBar Expanded	Enabled				
GS1-128	Enabled				
IATA 2 of 5	Disabled				
Standard 2 of 5	Disabled				
Interleaved 2 of 5	Enabled				
ISBT 128	Disabled				
Matrix 2 of 5	Disabled				
MSI	Disabled				
NEC 2 of 5					
Telepen	Disabled				
Trioptic Code	Disabled				
UPC-A	Enabled				
UPC-A/EAN-13 Extended	Disabled				
UPC-E	Enabled				
UPC-E1	Disabled				

# N6703SR Ultra-Slim Imager

*Time to Read and Depth of Field are impacted if the barcode symbol is at the edge of the image.*

## Guaranteed Specs (0 Lux)

Focus		Standard Range	
Symbology		Near Distance	Far Distance
5 mils Code 39	mm	79	270
	in.	3.11	10.63
10 mils Code 39	mm	40	450
	in.	1.57	17.72
20 mils Code 39	mm	44	674
	in.	1.73	26.53
13 mils 100% UPC-A	mm	44	515
	in.	1.73	202.7
15 mils Code 128	mm	42	572
	in.	1.65	22.52
10 mils Data Matrix	mm	83	236
	in.	3.27	9.29
5 mils PDF 417	mm	119	177
	in.	4.68	6.97
6.7 mils PDF 417	mm	96	236
	in.	3.78	9.29
7 mils QR	mm	123	147
	in.	4.84	5.79
15 mils QR	mm	39	390
	in.	1.54	15.35

### Typical Specs (200 Lux)

Focus		Standard Range	
Symbology		Near Distance	Far Distance
3 mils Code 39	mm	106	176.02
	in.	4.17	6.93
5 mils Code 39	mm	70	301
	in.	2.75	11.85
10 mils Code 39	mm	4	517
	in.	1.57	20.35
20 mils Code 39	mm	44	800
	in.	1.73	31.5
13 mils 100% UPC-A	mm	44	573
	in.	1.73	22.56
13 mils 20% UPC-A	mm	79	228
	in.	3.11	8.98
15 mils Code 128	mm	42	650
	in.	1.65	25.59
10 mils Data Matrix	mm	72	297
	in.	2.83	11.69
5 mils PDF 417	mm	105	181
	in.	4.13	7.12
6.7 mils PDF 417	mm	84	244
	in.	3.31	9.61
7 mils QR	mm	105	169
	in.	4.13	6.65
15 mils QR	mm	39	414
	in.	1.54	16.30

## N6703 Imager Field of View/Resolution

Focus	Standard Range (SR)
Horizontal Field Angle (degrees)	48 ± 2°
Vertical Field Angle (degrees)	31 ± 2°

*DPI can be calculated based on the following formula:*

*Horizontal DPI = 1280 pixels/width of horizontal field of view (inches)*

*Vertical DPI = 800 pixels/width of vertical field of view (inches)*

# N6803 FlexRange Imager

The depth of field measurements used the following parameters:

- Distances are measured from the front of the Imager.
- +23°C (+73°F), 200 lux for guaranteed, 200 lux for typical.
- Photographic quality codes

**Note:** *Time to Read and Depth of Field will be impacted if the barcode symbol is at the edge of the image.*

## Guaranteed Specs

Focus		Standard Range	
Symbology		Near Distance	Far Distance
5 mils Code 39	mm	138	365
	in.	5.43	14.4
10 mils Data Matrix	mm	152	387
	in.	6	15.23
10 mils Code 39	mm	94	1198
	in.	4	47.2
13 mils UPC-A	mm	68	1437
	in.	3	57
15 mils Code 128	mm	66	1571
	in.	3	62
20 mils Code 39	mm	63	2161
	in.	3	85.1
100 mils Data Matrix <sup>1</sup>	mm	368	4505
	in.	15	177.4
55 mils Code 39 <sup>1</sup>	mm	176	6546
	in.	7	258
100 mils Code 39 <sup>1,2</sup>	mm	300	9843
	in.	12	388
<sup>1</sup> Minimum distance depends on the length of the barcode. <sup>2</sup> Typical code wide- to-narrow elemental ratio is 3:1. Minimum 100 mils code height of 3 inches.			

## Typical Specs

Focus		Standard Range	
Symbology		Near Distance	Far Distance
5 mils Code 39	mm	122	414
	in.	5	16.3
10 mils Data Matrix	mm	135	419
	in.	5.3	17
10 mils Code 39	mm	85	1368
	in.	3.4	54
13 mils UPC-A	mm	60	1600
	in.	2.4	63
15 mils Code 128	mm	58	1894
	in.	2.3	75
20 mils Code 39	mm	56	2645
	in.	2.2	104.1
100 mils Data Matrix <sup>1</sup>	mm	338	5641
	in.	13.3	222.1
55 mils Code 39 <sup>1</sup>	mm	159	7159
	in.	6.3	282
100 mils Code 39 <sup>1,2</sup>	mm	275	10815
	in.	11	426
<sup>1</sup> Minimum distance depends on the length of the barcode. <sup>2</sup> Typical code wide-to-narrow elemental ratio is 3:1. Minimum 100 mil code height of 3 inches.			

## N6803FR Field of View/Resolution

### Near Field Optical System

- Horizontal FOV: 48°
- Vertical FOV: 21°

**Note:** DPI can be calculated based on the following formula:

*Horizontal DPI = 1920 pixels/width of horizontal field of view (inches)*

*Vertical DPI = 800 pixels/width of vertical field of view (inches)*



## Far Field Optical System

- Horizontal FOV: 20°
- Vertical FOV: 12°

**Note:** DPI can be calculated based on the following formula:

Horizontal DPI = 1280 pixels/width of horizontal field of view (inches)

Vertical DPI = 800 pixels/width of vertical field of view (inches)

## Port and Connector Pinouts

### Docking Connector

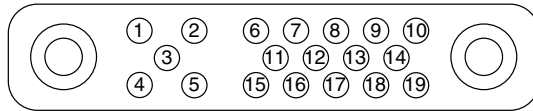

Pin	Description
1	RF_GND
2	DOCK_DET#
3	GPS ANT
4	RF_GND
5	RF_GND
6	NC
7	NC
8	DETECT+
9	Power
10	Power
11	NC
12	NC
13	GND
14	Power
15	USB+
16	USB-
17	GND
18	GND
19	DETECT-





Honeywell  
855 S. Mint Street  
Charlotte, NC 28202 USA

[sps.honeywell.com](https://sps.honeywell.com)